

saas creative top view

INSTRUCTIONS

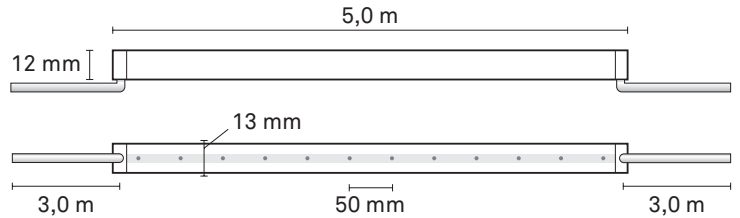

LED 9,6W/m	24V	640 lm/m	Ra 85	3 SDCM	IP67	DIM	15 x BRACKET
 -20°C ... +50°C		 50 mm	L90B10 50 000h	5 YEARS WARRANTY	60 mm MIN. BEND DIAMETER	CE	

Maximum 10 meter led strip/feed.
Maximalt 10 meter ledband/inmatning.
Enintään 10 metrin led-nauha/syöttö.

Precautions before installation

1: Indoor and outdoor use



2: No pedaling



3: No distortion

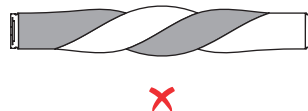

4: No stretching

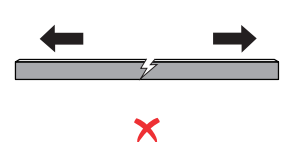

5: Operated by 2 people

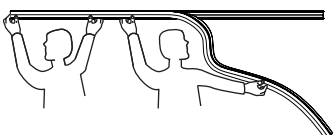

For 2 m or longer creative strips, it is recommended to install or detach by 2 people.

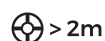

Creative top view bending radius and note

Top bending

1: Bending direction and min. radius

2: Side bending prohibited

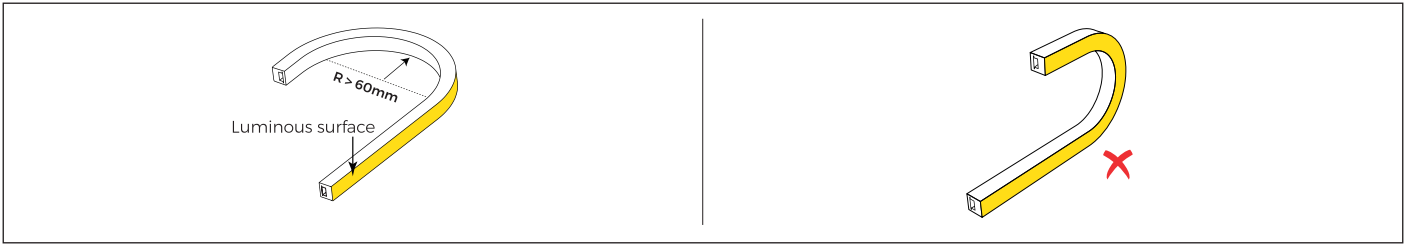

Note: Due to the different types and attributes of creative top view, please refer to the line marks for the bending radius.

Cutting creative top view

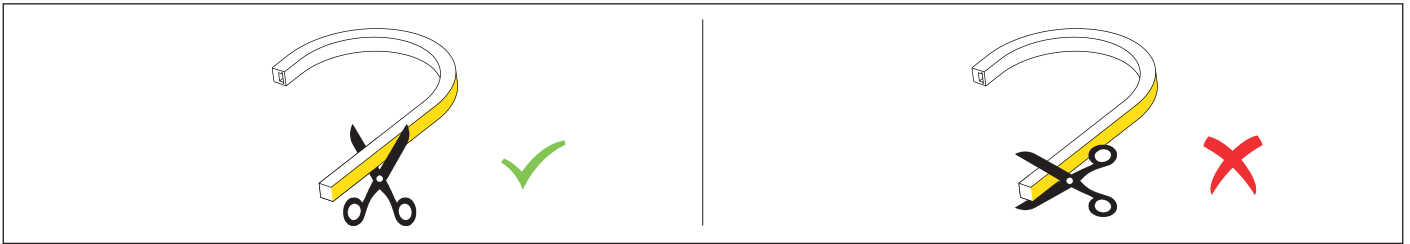

Installation with saas top view PC clip

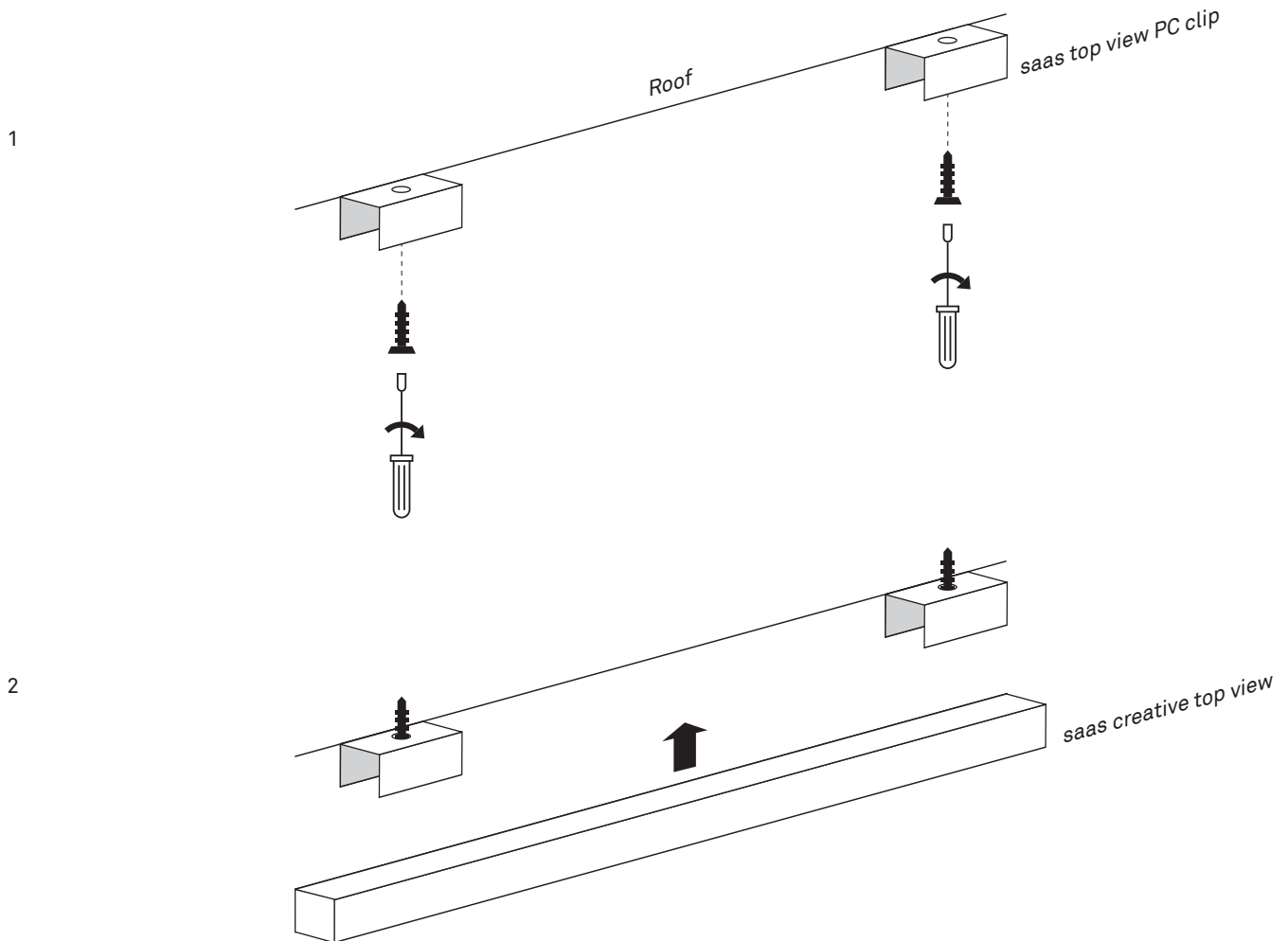

Optional installation to saas top view installation profile

1

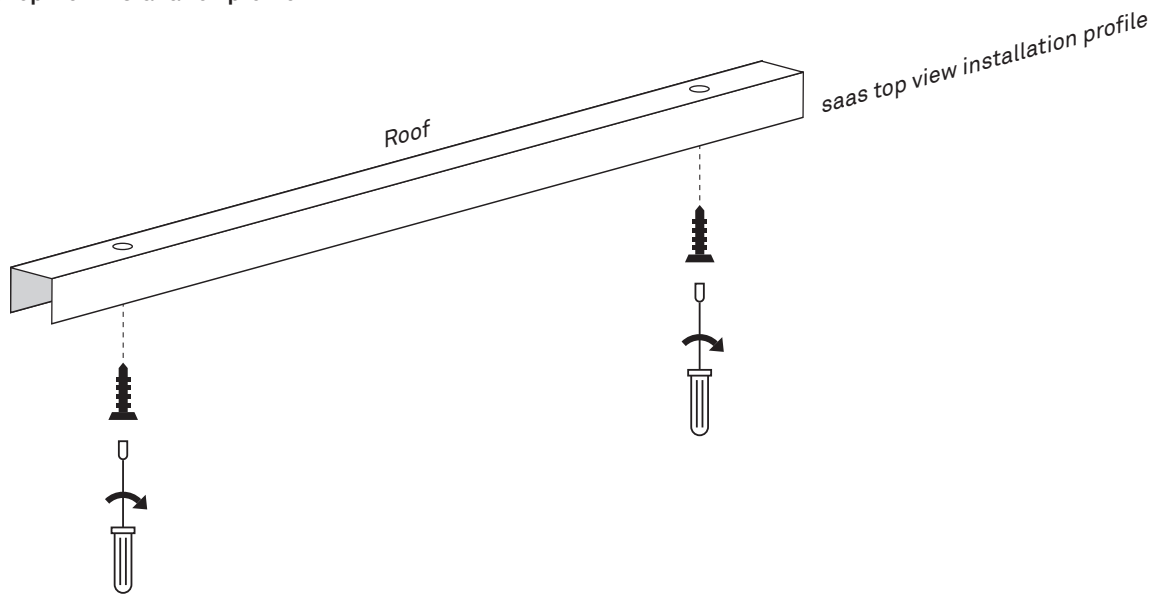

2

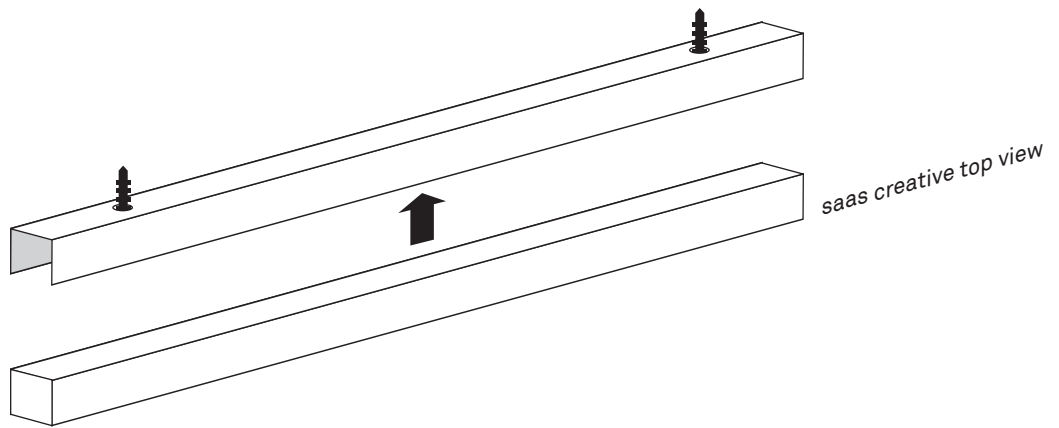

Connection of the ledstrip

Connection of the single ledstrip:

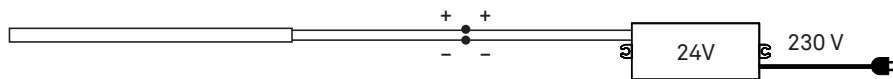

Connection of multiple ledstrips, connected in parallel:

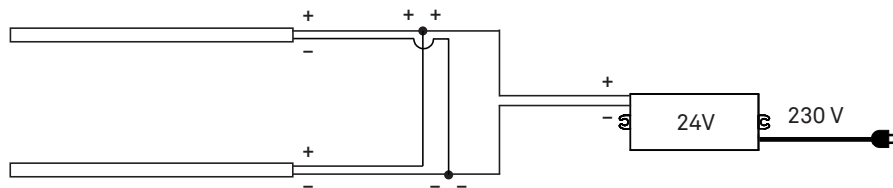

or:

