

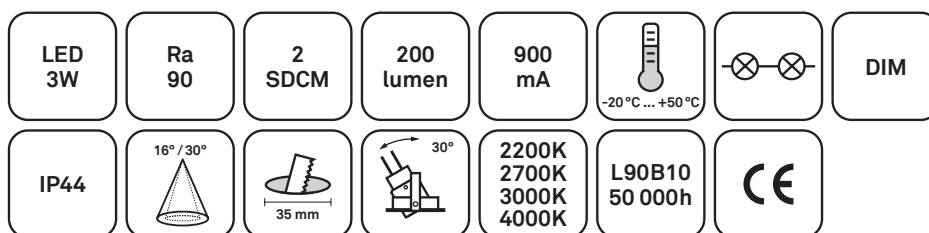

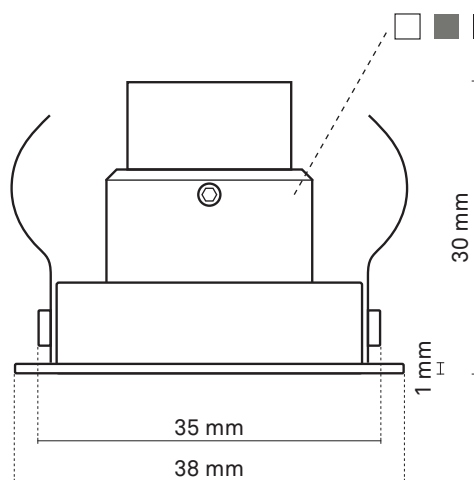







saas blaze pivot

1



Frame colors:
White, grey, black



		 Sähkönumerot	 E-Nummer	 Product numbers
saas blaze pivot white 16		2200K 41 314 82	74 767 50	1000 2662
		2700K 41 314 83	74 767 51	1000 2663
		3000K 41 314 84	74 767 52	1000 2664
		4000K 41 314 85	74 767 53	1000 2665
saas blaze pivot grey amber 16		2200K 41 314 98	74 767 66	1000 2678
		2700K 41 314 99	74 767 67	1000 2679
		3000K 41 334 00	74 767 68	1000 2680
		4000K 41 334 01	74 767 69	1000 2681
saas blaze pivot black 16		2200K 41 314 90	74 767 58	1000 2670
		2700K 41 314 91	74 767 59	1000 2671
		3000K 41 314 92	74 767 60	1000 2672
		4000K 41 314 93	74 767 61	1000 2673
saas blaze pivot white 30		2200K 41 314 86	74 767 54	1000 2666
		2700K 41 314 87	74 767 55	1000 2667
		3000K 41 314 88	74 767 56	1000 2668
		4000K 41 314 89	74 767 57	1000 2669
saas blaze pivot grey amber 30		2200K 41 334 02	74 767 70	1000 2682
		2700K 41 334 03	74 767 71	1000 2683
		3000K 41 334 04	74 767 72	1000 2684
		4000K 41 334 05	74 767 73	1000 2685
saas blaze pivot black 30		2200K 41 314 94	74 767 62	1000 2674
		2700K 41 314 95	74 767 63	1000 2675
		3000K 41 314 96	74 767 64	1000 2676
		4000K 41 314 97	74 767 65	1000 2677

Version: 14082023

