



SAUNA

LIGHTS NORTH OF THE 60<sup>TH</sup> LATITUDE

# INFO

1 + 2 + 3

## saas led



Neliöllä merkityt **saas** led-tuotteet ovat yhteensopivia keskenään.  
Led-produkterna markerade med en fyrkant är kompatibla sinsemellan.  
The led-products marked with a square are compatible with each other.

## saas strip



Ympyrällä merkityt **saas** led-nauhatuotteet ovat yhteensopivia keskenään.  
Led-produkterna markerade med en cirkel är kompatibla sinsemellan.  
The led-products marked with a circle are compatible with each other.





**FIN** Valaisimen keilan säädöllä voidaan hallita valokeilojen avautumista pinnalla. Kaventamalla keiloja saadaan valon ja varjon välinen upea kokonaisuus. Leventämällä keilaa saadaan hillitympi tasainen ja rauhoittava valokokonaisuus. **SWE** Genom att justera armatursens ljusstråle kan ljusets spridning på ytan regleras. Begränsningen av ljuskägorna skapar en fin kombination av ljus och skugga. Genom att utvidga ljuskäglan erhålls en mer dämpad, jämn och lugnande belysningshelhet. **ENG** Adjusting the beam of the fixture can control the output of the beam onto the surface. By narrowing the beams, a wonderful combination of light and shadow is achieved. Widening the beam creates a more understated even and soothing light entity.



|                |           |         |                |        |      |     |
|----------------|-----------|---------|----------------|--------|------|-----|
| LED 3W         | 100 lumen | 350 mA  | Ra 90          | 3 SDCM | IP44 | DIM |
| -30°C...+125°C | 15 mm     | 40°-80° | L70B50 10 000h | CE     |      |     |

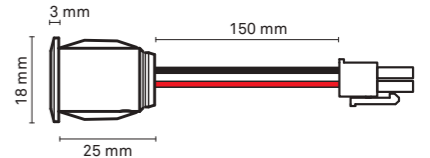

|       | Finland Sähkönumerot | Sweden E-Nummer | EU Product number |
|-------|----------------------|-----------------|-------------------|
| 2700K | 41 281 91            | 74 508 06       | 1000 0464         |
| 3000K | 41 069 16            | 74 527 88       | 1000 0459         |
| 4000K | 41 069 42            | 74 507 41       | 1000 0458         |
| 2700K | 41 281 92            | 74 507 08       | 1000 0463         |
| 3000K | 41 069 53            | 74 507 42       | 1000 0461         |
| 4000K | 41 069 54            | 74 507 43       | 1000 0457         |
| 2700K | 41 281 93            | 74 507 09       | 1000 0462         |
| 3000K | 41 069 57            | 74 507 44       | 1000 0460         |
| 4000K | 41 069 58            | 74 507 45       | 1000 0456         |



■ saas sauna id+

□ saas posh sauna glow

**FIN** Valaisimen "silmäluomi" peittää valopisteen. Valo heijastuu epäsuorasti, hienostuneen pehmeästi seinäpinnan kautta tilaan. **SWE** Ljuspunkten döljs bakom armaturens "ögonlock". Ljuset reflekteras finstämt och mjukt indirekt in i utrymmet via väggytan. **ENG** The "eyelid" of the fixture covers the light source. The light is indirectly reflected into the space from the wall surface in a refined and soft manner.

**FIN** Suomalaisesta männystä sorvattu puuvalaisin hehkuu kauniisti luoden saunaan pehmeän lämminsävyisen valaistuksen. **SWE** Den av finländsk furu handgjorda träarmaturen lyser vackert upp utrymmet och skapar ett mjukt, varmtontat ljus. **ENG** The wooden luminaire, hand-made out of Finnish pine, glows beautifully and creates a soft, warm-coloured lighting state.

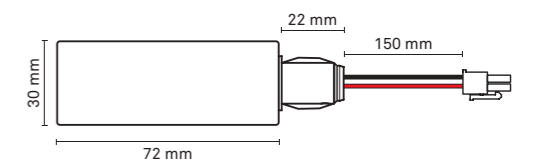
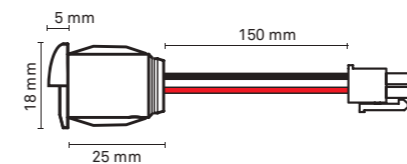
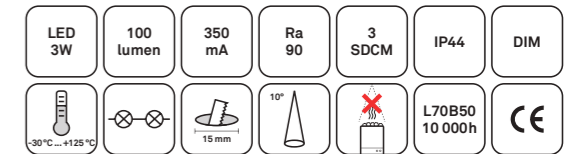
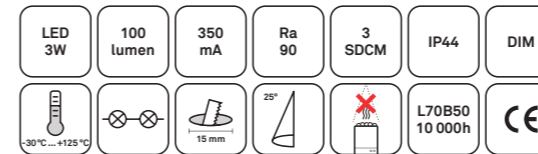

|        | Finland      | Sweden    | EU             |           |
|--------|--------------|-----------|----------------|-----------|
|        | Sähkönumerot | E-Nummer  | Product number |           |
| White  | 2700K        | 41 281 96 | 74 508 47      | 1000 0473 |
|        | 3000K        | 41 280 68 | 74 508 52      | 1000 0470 |
|        | 4000K        | 41 280 74 | 74 508 55      | 1000 0467 |
| Black  | 2700K        | 41 281 95 | 74 508 48      | 1000 0472 |
|        | 3000K        | 41 280 70 | 74 508 53      | 1000 0469 |
|        | 4000K        | 41 280 75 | 74 508 56      | 1000 0466 |
| Yellow | 2700K        | 41 281 94 | 74 508 49      | 1000 0471 |
|        | 3000K        | 41 280 72 | 74 508 54      | 1000 0468 |
|        | 4000K        | 41 280 76 | 74 508 57      | 1000 0465 |





|       | Finland      | Sweden    | EU             |
|-------|--------------|-----------|----------------|
|       | Sähkönumerot | E-Nummer  | Product number |
| 3000K | 41 281 10    | 74 508 95 | 1000 0477      |



## ● saas sauna viiva

**FIN** Saunaan soveltuva kiskovalaisin, joka on asennettavissa kattoon ja lauteeseen. Yhtenäinen valopinta luo tyylikkään valoviivan saunasta kylpyhuoneeseen. **SWE** saas viiva är en ljusprofil gjord för bastu. Profilen kan monteras i taket på bastun såväl som bänkarna. **ENG** saas viiva is a linear profile light for saunas that may be installed both in the seats and the ceiling of the sauna



|             |  |      |          |                |   |                   |   |
|-------------|--|------|----------|----------------|---|-------------------|---|
| LED<br>8W/m | 500<br>lm/m  | 24V  | Ra<br>95 | 3<br>SDCM      | 16x13<br>mm   | 2,5 m             | <br>70 mm |
| 2700K       | <br>30°C...+125°C | IP55 | DIM      | 4 x<br>BRACKET |  | L70B50<br>10 000h |          |

*Virtalähde hankittava erikseen  
Drivdon måste köpas separat  
Driver must be purchased separately*



Sähkönumerot  
41 314 29



E-Nummer  
75 069 40



Product number  
1000 1606





■ saas hot one

**FIN** Kiuasvalaisin jossa valopiste on tyylikäästi varjostimen takana. Varjostin rajaa valon kiukaalle ja korostaa siitä nousevan vesihöyryn kauniisti esille. Valaisinta voi käyttää yksinään tai siihen voi lisätä hot one+ -lisäosan.  
**SWE** Armatur för bastuugn med elegant bakom skärmen dold ljuskälla. Skärmen riktar ljuset mot ugnen och framhäver vackert den stigande vattenångan. Armaturen kan användas enskild eller i kombination med tilläggsdelen hot one+.  
**ENG** Sauna stove lighting with its light source elegantly placed behind a shade. The shade confines the light onto the stove and beautifully highlights the vapor. The lighting can be used by itself or with a hot one+ -accessory.

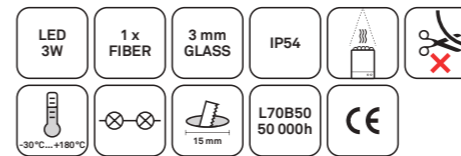

Kuitujen pituudet / Fiber längd / Fiber length  
 1 x 4,0 m / 3,0 mm + □-Ø 15 mm

|       |              |           |                |
|-------|--------------|-----------|----------------|
|       |              |           |                |
|       | Sähkönumerot | E-Nummer  | Product number |
| 3000K | 41 280 54    | 74 800 51 | 1000 0675      |

■ saas sauna basic

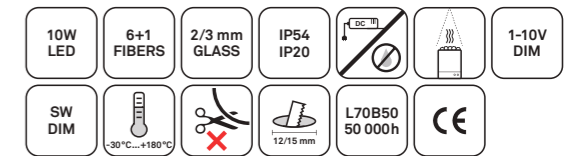

Kuitujen pituudet / Fiber längd / Fiber length  
 2 x 2,5 m / 2,0 mm + □-Ø 12 mm    2 x 3,0 m / 2,0 mm + □-Ø 12 mm  
 2 x 4,0 m / 2,0 mm + □-Ø 12 mm    1 x 5,0 m / 3,0 mm + □-Ø 15 mm

|  |              |           |                |
|--|--------------|-----------|----------------|
|  |              |           |                |
|  | Sähkönumerot | E-Nummer  | Product number |
|  | 41 280 51    | 74 800 02 | 1000 0672      |

■ saas hot one+

**FIN** Lisäosa hot one valaisimeen, hot one+ tuotteen voi myös liittää sauna LED-valaisimien johtosarjaan.  
**SWE** Tilläggsdel till hot one. Hot one+ kan även kopplas ihop på samma kabelserie som våra saas sauna LED-armaturer.  
**ENG** Accessory for the hot one light. The hot one+ can also be connected to the same wiring harness as our saas sauna LED fixtures.

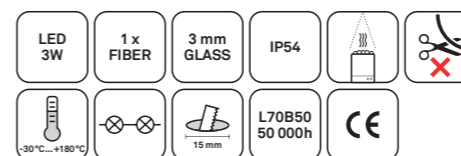

Kuitujen pituudet / Fiber längd / Fiber length  
 1 x 4,0 m / 3,0 mm + □-Ø 15 mm

|       |              |           |                |
|-------|--------------|-----------|----------------|
|       |              |           |                |
|       | Sähkönumerot | E-Nummer  | Product number |
| 3000K | 41 280 56    | 74 800 52 | 1000 0673      |

■ saas sauna sky

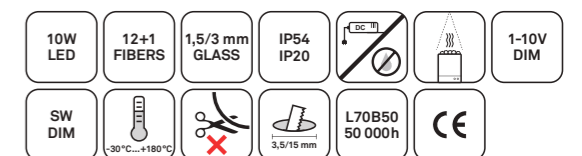

Kuitujen pituudet / Fiber längd / Fiber length  
 4 x 2,0 m / 1,5 mm    4 x 2,5 m / 1,5 mm  
 4 x 3,0 m / 1,5 mm    1 x 5,0 m / 3,0 mm + □-Ø 15 mm

|       |              |           |                |
|-------|--------------|-----------|----------------|
|       |              |           |                |
|       | Sähkönumerot | E-Nummer  | Product number |
| 3000K | 41 280 53    | 74 800 03 | 1000 0669      |



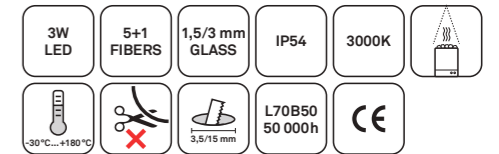

Kuitujen pituudet / Fiber längd / Fiber length  
 5 x 3,0 m / 1,5 mm  
 1 x 5,0 m / 3,0 mm +  $\square$   $\varnothing$  15 mm





■ saas löyly

**FIN** saas löyly luo kauniin epäsuoran ja pehmeän valon saunaan. Valaisimessa on mekaaninen valon avautumiskulman säätö, jolla valon avautumista voi vaivattomasti rajata vain valaisimen ympärille tai laajemmalle alueelle seinäpintaan. **SWE** saas löyly skapar ett vackert indirekt och mjukt ljus i din bastu. Armaturen har en mekanisk justering av ljusöppningsvinkeln. Ljusbängden kan alltså lätt begränsas endast runt armaturen eller över ett större område på väggytan. **ENG** saas löyly creates a beautiful indirect and soft light for your sauna. The luminaire has a mechanical adjustment for the light opening angle. This means the light opening can easily be limited to only around the luminaire or over a wider area on the wall.



|               |              |           |                   |          |      |     |
|---------------|--------------|-----------|-------------------|----------|------|-----|
| LED<br>6W     | 470<br>lumen | 230V      | CRI<br>80         | GX<br>53 | IP55 | DIM |
| -20°C...+60°C | 60°-80°      | MAX<br>1m | L70B50<br>10 000h | CE       |      |     |

Valaisin asennettava alle metrin korkeuteen!  
 Armaturen måste installeras på en höjd av mindre än en meter!  
 The luminaire must be installed at a height of less than one meter!

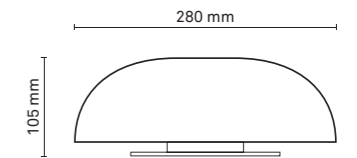

|         | 🇫🇮<br>Sähkönumerot | 🇸🇪<br>E-Nummer | 🇪🇺<br>Product number |
|---------|--------------------|----------------|----------------------|
| □ 2700K | 41 314 28          | 75 064 77      | 1000 1480            |
| ■ 2700K | 41 314 27          | 75 064 78      | 1000 1479            |

# DOWNLIGHTS





■ saas spot+

**FIN** Alasvalo säädettävällä valokeilalla luo hyvän ja näyttävän valaistuksen. Asennettaessa seinäpinnan lähelle, valaisin tuo valon tilaan korostaen samalla seinäpintaa. **SWE** Armatur med justerbar ljuskägla som skapar effektiv och dekorativ belysning. Installerad nära väggytan reflekteras ljuset in i rummet samtidigt som väggens yta accentueras. **ENG** Downlight with adjustable spotlight creates efficient and decorative lighting. When installed near a wall surface, the light is reflected into the room while emphasizing the wall surface.



|        |         |        |                         |                        |                   |     |
|--------|---------|--------|-------------------------|------------------------|-------------------|-----|
| LED 3W | Ra 90   | 3 SDCM | 100 lumen               | 350 mA                 | -20°C...+50°C     | DIM |
| IP44   | 40°-80° | 15 mm  | 2700K<br>3000K<br>4000K | 1 LED /m²<br>2 LED /m² | L90B10<br>50 000h | CE  |

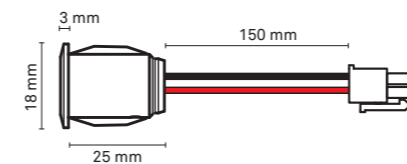

|        | Finland         | Sweden    | EU              |
|--------|-----------------|-----------|-----------------|
|        | Sähkönumerot    | E-Nummer  | Product numbers |
| Grey   | 2700K 41 281 82 | 74 506 99 | 1000 0455       |
|        | 3000K 41 069 22 | 74 527 94 | 1000 0448       |
|        | 4000K 41 069 48 | 74 507 81 | 1000 0447       |
| White  | 2700K 41 281 79 | 74 508 18 | 1000 0452       |
|        | 3000K 41 280 19 | 74 507 86 | 1000 0449       |
|        | 4000K 41 280 20 | 74 507 87 | 1000 0444       |
| Black  | 2700K 41 281 81 | 74 508 16 | 1000 0454       |
|        | 3000K 41 280 14 | 74 507 82 | 1000 0451       |
|        | 4000K 41 280 16 | 74 507 83 | 1000 0446       |
| Yellow | 2700K 41 281 80 | 74 508 17 | 1000 0453       |
|        | 3000K 41 280 17 | 74 507 84 | 1000 0450       |
|        | 4000K 41 280 18 | 74 507 85 | 1000 0445       |

■ saas wide+

**FIN** Laajakeilainen alasvalo levittää tilaan tasaisen lempeän valon. Hyllyjen korostuksessa saadaan yhdellä tai kahdella valaisimella keilaton tasainen valo. **SWE** Vidvinkel-armatur som sprider ett jämnt milt ljus i utrymmet. Accentueringen av hyllor skapar med hjälp av en eller två ljuspunkter ett ljus utan kägla. **ENG** The wide-angle downlight enables smooth distribution of gentle light in the space. By using one or two fixtures an even and beam-free light is achieved.



|        |       |        |                         |                        |                   |     |
|--------|-------|--------|-------------------------|------------------------|-------------------|-----|
| LED 3W | Ra 90 | 3 SDCM | 100 lumen               | 350 mA                 | -20°C...+50°C     | DIM |
| IP44   | 120°  | 15 mm  | 2700K<br>3000K<br>4000K | 1 LED /m²<br>2 LED /m² | L90B10<br>50 000h | CE  |

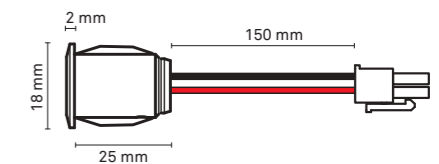

|        | Finland         | Sweden    | EU              |
|--------|-----------------|-----------|-----------------|
|        | Sähkönumerot    | E-Nummer  | Product numbers |
| Grey   | 2700K 41 281 83 | 74 508 08 | 1000 0431       |
|        | 3000K 41 069 18 | 74 527 90 | 1000 0424       |
|        | 4000K 41 069 44 | 74 507 53 | 1000 0423       |
| White  | 2700K 41 281 86 | 74 507 26 | 1000 0428       |
|        | 3000K 41 069 84 | 74 507 58 | 1000 0425       |
|        | 4000K 41 069 88 | 74 507 59 | 1000 0420       |
| Black  | 2700K 41 281 84 | 74 507 24 | 1000 0430       |
|        | 3000K 41 069 80 | 74 507 54 | 1000 0427       |
|        | 4000K 41 069 81 | 74 507 55 | 1000 0422       |
| Yellow | 2700K 41 281 85 | 74 507 25 | 1000 0429       |
|        | 3000K 41 069 82 | 74 507 56 | 1000 0426       |
|        | 4000K 41 069 83 | 74 507 57 | 1000 0421       |



■ saas step+

■ saas diagonal



**FIN** Askelma valaistuu hillitysti step-valaisimella. Kattopintaan asennettaessa valopiste katoaa täysin silmäluomen taakse piiloon ja valo laskeutuu lempeästi pintaa pitkin tasaisena valaistuksena aina lattiaan saakka.  
**SWE** Med step-armaturen framhävs trappsteget med en dämpad belysning. Installerad i taket är ljuskällan helt dold bakom locket och ljuset får sänka sig mjukt längsmed ytan som en jämnt sken ända ned till golvet.  
**ENG** The step is highlighted through subdued illumination. Installed in the ceiling, the light source is completely hidden behind the eyelid and allows the light to softly descend along the surface as even illumination all the way to the floor.



|        |       |           |                   |                     |                |
|--------|-------|-----------|-------------------|---------------------|----------------|
| LED 3W | Ra 90 | 100 lumen | 350 mA            | -20°C...+50°C       | DIM            |
| IP44   | 25°   | 15 mm     | 2700K 3000K 4000K | 1 LED /m² 2 LED /m² | L90B10 50 000h |
| CE     |       |           |                   |                     |                |

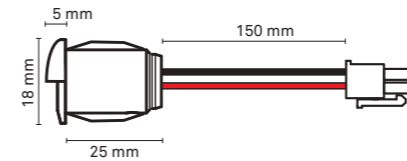

|        | Finland Sähkönumerot | Sweden E-Nummer | Product numbers |
|--------|----------------------|-----------------|-----------------|
| Grey   | 2700K 41 281 87      | 74 508 10       | 1000 0443       |
|        | 3000K 41 069 20      | 74 527 92       | 1000 0436       |
|        | 4000K 41 069 46      | 74 507 67       | 1000 0435       |
| White  | 2700K 41 281 90      | 74 508 12       | 1000 0440       |
|        | 3000K 41 280 05      | 74 507 72       | 1000 0437       |
|        | 4000K 41 280 06      | 74 507 73       | 1000 0432       |
| Black  | 2700K 41 281 88      | 74 508 02       | 1000 0442       |
|        | 3000K 41 069 97      | 74 507 68       | 1000 0439       |
|        | 4000K 41 069 98      | 74 507 69       | 1000 0434       |
| Yellow | 2700K 41 281 89      | 74 508 11       | 1000 0441       |
|        | 3000K 41 069 99      | 74 507 70       | 1000 0438       |
|        | 4000K 41 280 04      | 74 507 71       | 1000 0433       |

**FIN** Alasvalon viisto varjostinrunko ajaa valon seinäpinnalle pyyhkien pintaa kauniisti valollaan aina lattiaan asti. Säädettävällä valokeilalla loihditaan tilaan yksilöllisiä kokonaisuuksia.  
**SWE** Armaturens sneddade skärmdel styr ljuset mot väggytan och belyser den med vackert ljus ända ner till golvet. Den justerbara ljuskäglan skapar unika belysningshelheter i utrymmet.  
**ENG** The slanted shade of this downlight directs the light onto the wall surface, sweeping it beautifully all the way to the floor. The adjustable spotlight forms individual entities in the space.



|        |         |        |                   |                     |                |     |
|--------|---------|--------|-------------------|---------------------|----------------|-----|
| LED 3W | Ra 90   | 3 SDCM | 100 lumen         | 350 mA              | -20°C...+50°C  | DIM |
| IP44   | 40°-60° | 15 mm  | 2700K 3000K 4000K | 1 LED /m² 2 LED /m² | L90B10 50 000h | CE  |

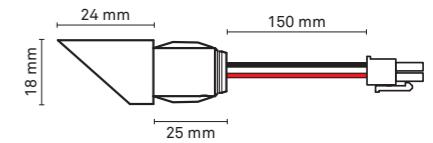

|        | Finland Sähkönumerot | Sweden E-Nummer | Product numbers |
|--------|----------------------|-----------------|-----------------|
| Grey   | 2700K 41 281 98      | 74 507 04       | 1000 0504       |
|        | 3000K 41 069 35      | 74 526 79       | 1000 0500       |
|        | 4000K 41 280 24      | 74 507 88       | 1000 0499       |
| White  | 2700K 41 314 01      | 74 508 21       | 1000 0505       |
|        | 3000K 41 281 98      | 74 507 93       | 1000 0501       |
|        | 4000K 41 280 32      | 74 507 94       | 1000 0496       |
| Black  | 2700K 41 281 99      | 74 508 19       | 1000 0507       |
|        | 3000K 41 280 25      | 74 507 89       | 1000 0503       |
|        | 4000K 41 280 26      | 74 507 90       | 1000 0498       |
| Yellow | 2700K 41 314 00      | 74 508 20       | 1000 0506       |
|        | 3000K 41 280 28      | 74 507 91       | 1000 0502       |
|        | 4000K 41 280 29      | 74 507 92       | 1000 0497       |



saas focus

**FIN** Suunnattava valaisin valokeilan säädöllä toimii tilassa kuin tilassa. Siro koko mahdollistaa valaisimen huomaamattoman asennuksen. Valo toimii koko tilan valaistuksena ja sillä voidaan helposti nostaa tilassa olevia yksityiskohtia esiin esim. takka. **SWE** Den riktbara punktbelysningen fungerar i vilket som helst utrymme. Den lilla storleken möjliggör diskret installation av armaturen. Ljuset fungerar som belysning för hela utrymmet och kan enkelt markera detaljer i rummet, såsom till exempel en öppen spis. **ENG** The directional spotlight with beam angle control is suited for every type of space. Its petite size allows unobtrusive installation. It works as ambient lighting and is well suited for accentuating details of a space, such as a fireplace.



|        |         |        |                   |                     |               |      |                |
|--------|---------|--------|-------------------|---------------------|---------------|------|----------------|
| LED 3W | Ra 90   | 3 SDCM | 100 lumen         | 350 mA              | -20°C...+50°C | ⊗    | DIM            |
| IP44   | 40°-60° | 15 mm  | 2700K 3000K 4000K | 1 LED /m² 2 LED /m² | 180°          | 360° | L90B10 50 000h |
| CE     |         |        |                   |                     |               |      |                |

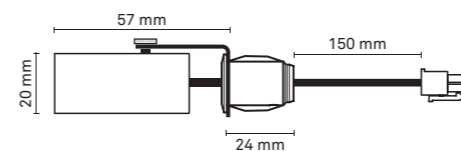

|       | Finland         | Sweden    | EU              |
|-------|-----------------|-----------|-----------------|
|       | Sähkönumerot    | E-Nummer  | Product numbers |
| White | 2700K 41 314 03 | 74 507 05 | 1000 0492       |
|       | 3000K 41 069 34 | 74 526 78 | 1000 0489       |
|       | 4000K 41 280 37 | 74 507 99 | 1000 0488       |
| Black | 2700K 41 314 02 | 74 508 87 | 1000 0491       |
|       | 3000K 41 280 96 | 74 508 88 | 1000 0490       |
|       | 4000K 41 280 97 | 74 508 89 | 1000 0487       |

saas power focus

**FIN** Suuntausvalaisin koko tilan valaistukseen. Valaisimessa on valokeilan säätömahdollisuus, jolla voi muuttaa valon ulostulon asennuksen jälkeen tilan tunnelmaan sopivaksi. **SWE** Riktbar armatur för belysning av hela utrymmet. Armaturen har en justeringsmöjlighet av ljuskäglan så att den perfekta atmosfären kan uppnås också efter installation. **ENG** Directional light for lighting of an entire space. The fixture has a beam control function enabling post-installation adjustment of the light output to suit the mood of the space.



|        |         |        |                   |                     |               |      |                |
|--------|---------|--------|-------------------|---------------------|---------------|------|----------------|
| LED 6W | Ra 90   | 3 SDCM | 500 lumen         | 500 mA              | -20°C...+50°C | ⊗    | DIM            |
| IP44   | 40°-50° | 15 mm  | 2700K 3000K 4000K | 1 LED /m² 2 LED /m² | 180°          | 360° | L90B10 50 000h |
| CE     |         |        |                   |                     |               |      |                |

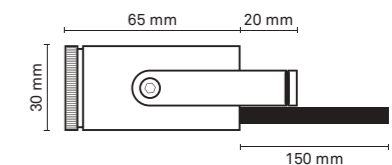

|       | Finland         | Sweden    | EU              |
|-------|-----------------|-----------|-----------------|
|       | Sähkönumerot    | E-Nummer  | Product numbers |
| White | 2700K 41 281 28 | 74 513 94 | 1000 0534       |
|       | 3000K 41 281 29 | 74 513 95 | 1000 0531       |
|       | 4000K 41 281 30 | 74 513 96 | 1000 0528       |
| Black | 2700K 41 281 31 | 74 513 97 | 1000 0533       |
|       | 3000K 41 281 32 | 74 513 98 | 1000 0530       |
|       | 4000K 41 281 33 | 74 513 99 | 1000 0527       |
| Grey  | 2700K 41 281 34 | 74 514 00 | 1000 0532       |
|       | 3000K 41 281 35 | 74 514 01 | 1000 0529       |
|       | 4000K 41 281 36 | 74 514 02 | 1000 0526       |

## saas power spot

**FIN** Alasvalossa valo laskeutuu tilaan huomaamattomasti sisennetyn valopisteen ansiosta. Valaisimen runko-osaa kiertämällä saadaan tilan valaistusta muunneltua. **SWE** Downlight med ljuskägla som diskret lyser upp utrymmet tack vare sin insänkta ljuskälla. Ljuset kan enkelt justeras genom att vrida lampkroppen, för att förändra belysningen i ett utrymme. **ENG** This downlight lets the light unobtrusively descend into the space due to its indented light source. The light can easily be adjusted by twisting the frame, to modify the illumination of a space.



|        |         |        |                         |                          |                   |     |
|--------|---------|--------|-------------------------|--------------------------|-------------------|-----|
| LED 6W | Ra 90   | 3 SDCM | 500 lumen               | 500 mA                   | -20°C...+50°C     | DIM |
| IP44   | 20°-50° | 54 mm  | 2700K<br>3000K<br>4000K | 1 LED /2m²<br>2 LED /2m² | L90B10<br>50 000h | CE  |

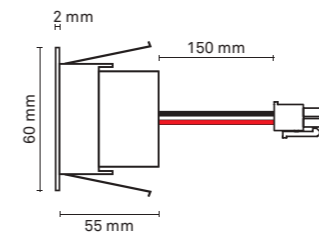

|       | Fin Sähkönumerot | Swe E-Nummer | EU Product numbers |
|-------|------------------|--------------|--------------------|
| White | 2700K 41 314 06  | 74 679 23    | 1000 0513          |
|       | 3000K 41 280 39  | 74 506 95    | 1000 0512          |
|       | 4000K 41 280 43  | 74 506 96    | 1000 0511          |
| Grey  | 2700K 41 314 08  | 74 679 26    | 1000 0510          |
|       | 3000K 41 280 40  | 74 506 85    | 1000 0509          |
|       | 4000K 41 280 44  | 74 506 86    | 1000 0508          |
| Black | 2700K 41 314 07  | 74 679 31    | 1000 0516          |
|       | 3000K 41 280 38  | 74 506 87    | 1000 0515          |
|       | 4000K 41 280 42  | 74 506 92    | 1000 0514          |

## saas power spot R

**FIN** Alasvalossa valo laskeutuu tilaan huomaamattomasti sisennetyn valopisteen ansiosta. Valaisimen runko-osaa kiertämällä saadaan tilan valaistusta muunneltua. **SWE** Downlight med ljuskägla som diskret lyser upp utrymmet tack vare sin insänkta ljuskälla. Ljuset kan enkelt justeras genom att vrida lampkroppen, för att förändra belysningen i ett utrymme. **ENG** This downlight lets the light unobtrusively descend into the space due to its indented light source. The light can easily be adjusted by twisting the frame, to modify the illumination of a space.



|        |         |        |                         |                          |                   |     |
|--------|---------|--------|-------------------------|--------------------------|-------------------|-----|
| LED 6W | Ra 90   | 3 SDCM | 500 lumen               | 500 mA                   | -20°C...+50°C     | DIM |
| IP44   | 20°-50° | 54 mm  | 2700K<br>3000K<br>4000K | 1 LED /2m²<br>2 LED /2m² | L90B10<br>50 000h | CE  |

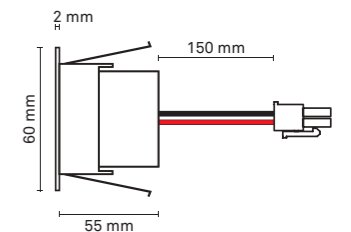

|       | Fin Sähkönumerot | Swe E-Nummer | EU Product numbers |
|-------|------------------|--------------|--------------------|
| White | 2700K 41 281 19  | 74 513 85    | 1000 0525          |
|       | 3000K 41 281 20  | 74 513 86    | 1000 0522          |
|       | 4000K 41 281 21  | 74 513 87    | 1000 0519          |
| Grey  | 2700K 41 281 22  | 74 513 88    | 1000 0523          |
|       | 3000K 41 281 23  | 74 513 89    | 1000 0520          |
|       | 4000K 41 281 24  | 74 513 90    | 1000 0517          |
| Black | 2700K 41 281 25  | 74 513 91    | 1000 0524          |
|       | 3000K 41 281 26  | 74 513 92    | 1000 0521          |
|       | 4000K 41 281 27  | 74 513 93    | 1000 0518          |



□ saas posh hidden

**FIN** Valaisimesta jää pinnalle näkyviin kaunis siro kaulus, joka luo yksilöllisen ilmeen. Sisennetty valonlähde poistaa häikäisyn ja pehmentää valaistusta. Valokeilan säädöllä saat kohdennettua valoa juuri sinne missä sitä tarvitaan. **SWE** Armaturens eleganta krage förblir synlig på ytan där den installeras och utgör en unik del av inredningen. Den infällda ljuskällan eliminerar bländning och mjukar upp ljuset. Genom att justera ljuskäglan kan ljuset riktas exakt dit det behövs. **ENG** The beautiful slim sleeve of the fixture remains visible on the installation surface, creating a unique look. The indented light source eliminates glare and softens the light. By adjusting the light beam, the light can be directed exactly where it is needed.



|        |         |        |             |                     |                 |    |     |
|--------|---------|--------|-------------|---------------------|-----------------|----|-----|
| LED 3W | Ra 90   | 3 SDCM | 100 lumen   | 350 mA              | -20°C ... +50°C | ⊗  | DIM |
| IP44   | 40°-60° | 15 mm  | 3000K 4000K | 1 LED /m² 2 LED /m² | L90B10 50 000h  | CE |     |

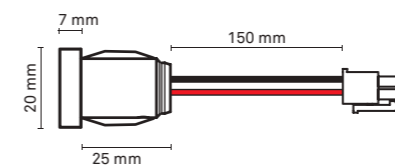

|   | Finland Sähkönumerot | Sweden E-Nummer | EU Product numbers |
|---|----------------------|-----------------|--------------------|
| ■ | 2700K 41 314 09      | 74 514 39       | 1000 0483          |
|   | 3000K 41 281 11      | 74 508 93       | 1000 0481          |
|   | 4000K 41 281 12      | 74 508 94       | 1000 0479          |
| □ | 2700K 41 314 10      | 74 514 40       | 1000 0482          |
|   | 3000K 41 314 11      | 74 510 41       | 1000 0480          |
|   | 4000K 41 314 12      | 74 510 42       | 1000 0478          |

saas posh diamond

**FIN** Valaisimen voi helposti yhdistää usean saas tuoteperheen tuotteen kanssa. Valaisin on käsinhiottua kristallia, joka toimii katseenvangitsijana ja tuo tilaan ylellistä ilmettä ja säihkettä. **SWE** Armaturen kan enkelt kombineras med flera av saas -produktfamiljens produkter. Den handslipade kristallarmaturen fungerar som blickfångare och ger utrymmet ett lyxigt och strålande utseende. **ENG** The light can easily be combined with multiple saas product family items. The hand-polished crystal light fixture acts as an eye catcher and gives a space a luxurious look and radiance.



|        |       |        |           |                |                 |   |  |
|--------|-------|--------|-----------|----------------|-----------------|---|--|
| LED 3W | Ra 90 | 3 SDCM | 100 lumen | 350 mA         | -20°C ... +50°C | ⊗ |  |
| DIM    | IP44  | 15 mm  | 3000K     | L90B10 50 000h | CE              |   |  |

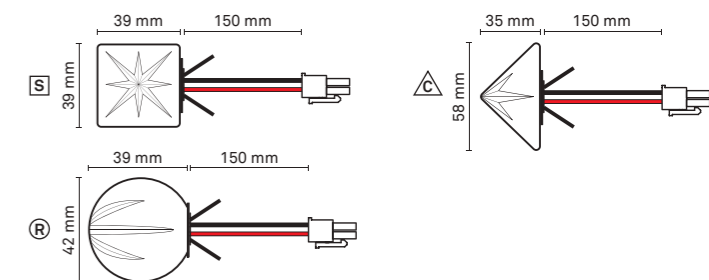

|   | Finland Sähkönumerot | Sweden E-Nummer | EU Product numbers |
|---|----------------------|-----------------|--------------------|
| ⊗ | 3000K 41 280 78      | 74 508 59       | 1000 0484          |
| ⊗ | 3000K 41 280 79      | 74 508 60       | 1000 0485          |
| ⊗ | 3000K 41 280 77      | 74 508 58       | 1000 0486          |



saas posh hidden

# saas blaze

**FIN** saas blaze on täydellinen yhdistelmä kompaktia kokoa ja tehokasta valoa. Tässä spottivalaisimessa on korkealaatuinen linssi ja haloefekti, jotka tekevät siitä täydellisen melkein mihin tahansa tilaan. Valaisimet on helppo asentaa ilman liitäntään tarvittavia työkaluja. **SWE** saas blaze är den perfekta kombinationen av kompakt storlek och effektiv ljusstyrka. Denna minimalistiska spotlight är försedd med en högklassig lens och skapar en vacker ljuskran. Armaturen är lätt att installera och kopplingen kräver inga verktyg. **ENG** The saas blaze is the perfect combination between compact in size and sufficient in light. This spotlight benefits from a high-quality lens and a halo effect that makes it perfect for just about any space. The fixtures are easy to install with no tools needed for the connection.



|        |         |        |                                  |                   |               |     |
|--------|---------|--------|----------------------------------|-------------------|---------------|-----|
| LED 3W | Ra 90   | 2 SDCM | 200 lumen                        | 900 mA            | -20°C...+50°C | DIM |
| IP44   | 16°/30° | 22 mm  | 2200K<br>2700K<br>3000K<br>4000K | L90B10<br>50 000h | CE            |     |

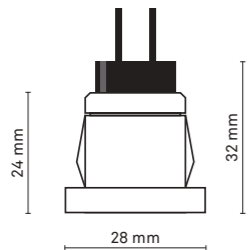

|                          |       | Finland      | Sweden   | Product numbers |
|--------------------------|-------|--------------|----------|-----------------|
|                          |       | Sähkönumerot | E-Nummer |                 |
| saas blaze white 16      | 2200K | 41 314 57    |          | 1000 2636       |
|                          | 2700K | 41 314 59    |          | 1000 2637       |
|                          | 3000K | 41 314 60    |          | 1000 2638       |
|                          | 4000K | 41 314 61    |          | 1000 2639       |
| saas blaze grey amber 16 | 2200K | 41 314 74    |          | 1000 2654       |
|                          | 2700K | 41 314 75    |          | 1000 2655       |
|                          | 3000K | 41 314 76    |          | 1000 2656       |
|                          | 4000K | 41 314 77    |          | 1000 2657       |
| saas blaze black 16      | 2200K | 41 314 66    |          | 1000 2646       |
|                          | 2700K | 41 314 67    |          | 1000 2647       |
|                          | 3000K | 41 314 68    |          | 1000 2648       |
|                          | 4000K | 41 314 69    |          | 1000 2649       |
| saas blaze white 30      | 2200K | 41 314 62    |          | 1000 2640       |
|                          | 2700K | 41 314 63    |          | 1000 2642       |
|                          | 3000K | 41 314 64    |          | 1000 2644       |
|                          | 4000K | 41 314 65    |          | 1000 2645       |
| saas blaze grey amber 30 | 2200K | 41 314 78    |          | 1000 2658       |
|                          | 2700K | 41 314 79    |          | 1000 2659       |
|                          | 3000K | 41 314 80    |          | 1000 2660       |
|                          | 4000K | 41 314 81    |          | 1000 2661       |
| saas blaze black 30      | 2200K | 41 314 70    |          | 1000 2650       |
|                          | 2700K | 41 314 71    |          | 1000 2651       |
|                          | 3000K | 41 314 72    |          | 1000 2652       |
|                          | 4000K | 41 314 73    |          | 1000 2653       |

# saas blaze pivot

**FIN** saas blaze pivot yhdistää ensiluokkaisen optiikan ja valonlähteen. Valaisimen kapeampi optiikka korostaa kohdistettuna yksityiskohtia ja laajemmalla optiikalla saadaan tiloihin dynaamisia valaistuskokonaisuuksia. Valaisimet on helppo asentaa ilman liitäntään tarvittavia työkaluja. **SWE** saas blaze pivot kombinerar en högklassig optik med en ljuskälla som är riktbar och kan betona detaljer, samt skapa en mer dynamisk ljusbild i ett utrymme. Armaturen är lätt att installera och kopplingen kräver inga verktyg. **ENG** The saas blaze pivot combines first class optics and light source. Light can be targeted with narrow lens in one direction to highlight objects or create dynamic effects by using wider lens. The fixtures are easy to install with no tools needed for the connection.



|        |         |        |                                  |                   |               |     |
|--------|---------|--------|----------------------------------|-------------------|---------------|-----|
| LED 3W | Ra 90   | 2 SDCM | 200 lumen                        | 900 mA            | -20°C...+50°C | DIM |
| IP44   | 16°/30° | 35 mm  | 2200K<br>2700K<br>3000K<br>4000K | L90B10<br>50 000h | CE            |     |

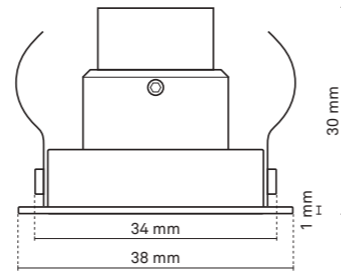

|                                |       | Finland      | Sweden   | Product numbers |
|--------------------------------|-------|--------------|----------|-----------------|
|                                |       | Sähkönumerot | E-Nummer |                 |
| saas blaze pivot white 16      | 2200K | 41 314 82    |          | 1000 2662       |
|                                | 2700K | 41 314 83    |          | 1000 2663       |
|                                | 3000K | 41 314 84    |          | 1000 2664       |
|                                | 4000K | 41 314 85    |          | 1000 2665       |
| saas blaze pivot grey amber 16 | 2200K | 41 314 98    |          | 1000 2678       |
|                                | 2700K | 41 314 99    |          | 1000 2679       |
|                                | 3000K | 41 334 00    |          | 1000 2680       |
|                                | 4000K | 41 334 01    |          | 1000 2681       |
| saas blaze pivot black 16      | 2200K | 41 314 90    |          | 1000 2670       |
|                                | 2700K | 41 314 91    |          | 1000 2671       |
|                                | 3000K | 41 314 92    |          | 1000 2672       |
|                                | 4000K | 41 314 93    |          | 1000 2673       |
| saas blaze pivot white 30      | 2200K | 41 314 86    |          | 1000 2666       |
|                                | 2700K | 41 314 87    |          | 1000 2667       |
|                                | 3000K | 41 314 88    |          | 1000 2668       |
|                                | 4000K | 41 314 89    |          | 1000 2669       |
| saas blaze pivot grey amber 30 | 2200K | 41 334 02    |          | 1000 2682       |
|                                | 2700K | 41 334 03    |          | 1000 2683       |
|                                | 3000K | 41 334 04    |          | 1000 2684       |
|                                | 4000K | 41 334 05    |          | 1000 2685       |
| saas blaze pivot black 30      | 2200K | 41 314 94    |          | 1000 2674       |
|                                | 2700K | 41 314 95    |          | 1000 2675       |
|                                | 3000K | 41 314 96    |          | 1000 2676       |
|                                | 4000K | 41 314 97    |          | 1000 2677       |

# saas blaze stair

**FIN** saas blaze stair -valaisin sopii täydellisesti sekä portaisiin, kattoon että seiniin. Piilotetun valonlähteen ansiosta häikäisy on minimoitu ja samalla se kohdistaa valon alaspäin valaisemaan kulkua. IP65-luokituksensa ansiosta tämä valaisin toimii täydellisesti myös ulkotiloissa. **SWE** Saas blaze stair är den perfekta armaturen för både trappor, tak, och väggar. Med sin gömda ljuskälla begränsas bländnings effekten samtidigt som ljuset fokuseras neråt för att lysa upp trapporna. Saas blaze är klassad som IP65 vilket gör den perfekt även för utomhusbruk. **ENG** The saas blaze stair is the perfect fixture for both your stairs, ceilings, and walls. With its hidden light source, the glare is limited while at the same time focusing the light downwards to illuminate your path. With its IP65 rating this fixture also works perfectly in outdoor environments.



|        |       |        |                                  |                   |               |     |
|--------|-------|--------|----------------------------------|-------------------|---------------|-----|
| LED 3W | Ra 90 | 2 SDCM | 200 lumen                        | 900 mA            | -20°C...+50°C | DIM |
| IP65   | 60°   | 22 mm  | 2200K<br>2700K<br>3000K<br>4000K | L90B10<br>50 000h | CE            |     |

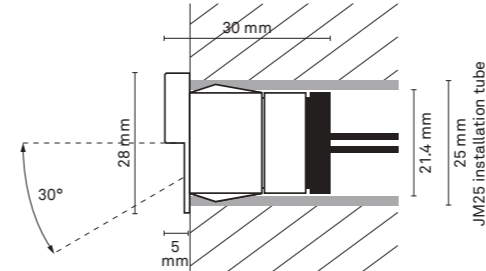

|                                |       | Finland      | Sweden   | Product numbers |
|--------------------------------|-------|--------------|----------|-----------------|
|                                |       | Sähkönumerot | E-Nummer |                 |
| saas blaze stair white 60      | 2200K | 45 158 22    |          | 1000 2686       |
|                                | 2700K | 45 158 23    |          | 1000 2687       |
|                                | 3000K | 45 158 24    |          | 1000 2688       |
|                                | 4000K | 45 158 25    |          | 1000 2689       |
| saas blaze stair grey amber 60 | 2200K | 45 158 30    |          | 1000 2694       |
|                                | 2700K | 45 158 31    |          | 1000 2695       |
|                                | 3000K | 45 158 32    |          | 1000 2696       |
|                                | 4000K | 45 158 33    |          | 1000 2697       |
| saas blaze stair black 60      | 2200K | 45 158 26    |          | 1000 2690       |
|                                | 2700K | 45 158 27    |          | 1000 2691       |
|                                | 3000K | 45 158 28    |          | 1000 2692       |
|                                | 4000K | 45 158 29    |          | 1000 2693       |







saas dim



350mA 500mA 900mA IP20 1-12 LED 3W / 350mA 1-7 LED 3W / 900mA 1-4 LED 6W 1-10V DIM SW DIM SYNC

3W LED 350mA 1-12 LED DIP 1 2 3 4 5 6 3W LED 900mA 1-7 LED DIP 1 2 3 4 5 6 6W LED 500mA 1-4 LED DIP 1 2 3 4 5 6

Sähkönumerot 41 069 32 E-Nummer 79 840 14 Product numbers 1000 0550

saas dim bluetooth



CASAMBI Available on the App Store Google play

350mA 500mA 900mA IP20 1-12 LED 3W / 350mA 1-12 LED 3W / 900mA 1-4 LED 6W SYNC DALI

3W LED 350mA 1-12 LED DIP 1 2 3 4 3W LED 900mA 1-12 LED DIP 1 2 3 4 6W LED 500mA 1-4 LED DIP 1 2 3 4

Sähkönumerot 40 190 39 E-Nummer Product numbers 1000 1821

saas maxi dim



350mA 500mA 900mA IP20 1-16 LED 3W / 350mA 1-16 LED 3W / 900mA 1-6 LED 6W 1-10V DIM SW DIM SYNC DALI

3W LED 350mA 1-16 LED DIP 1 2 3 4 5 6 3W LED 900mA 1-16 LED DIP 1 2 3 4 5 6 6W LED 500mA 1-6 LED DIP 1 2 3 4 5 6

Sähkönumerot 41 280 45 E-Nummer 79 809 60 Product numbers 1000 0542

saas maxi dim bluetooth



CASAMBI Available on the App Store Google play

350mA 500mA 900mA IP20 1-16 LED 3W / 350mA 1-16 LED 3W / 900mA 1-6 LED 6W SW DIM SYNC DALI

3W LED 350mA 1-16 LED DIP 1 2 3 4 5 6 3W LED 900mA 1-16 LED DIP 1 2 3 4 5 6 6W LED 500mA 1-6 LED DIP 1 2 3 4 5 6

Sähkönumerot 40 190 40 E-Nummer Product numbers 1000 1820

saas dim R



350mA IP20 1-8 LED (3W) 1-10V DIM SW DIM

3W LED 350mA 1-12 LED DIP 1 2 3 4 5 6 6W LED 500mA 1-4 LED DIP 1 2 3 4 5 6

Sähkönumerot 40 190 13 E-Nummer 79 813 90 Product numbers 1000 0549

saas dim TRIAC



350mA 500mA IP20 1-12 LED (3W) 1-4 LED (6W) 1-10V DIM SW DIM SYNC

3W LED 350mA 1-12 LED DIP 1 2 3 4 5 6 6W LED 500mA 1-4 LED DIP 1 2 3 4 5 6

Sähkönumerot 40 190 29 E-Nummer Product numbers 1000 1635

saas driver



saas driver  
 Sähkönumerot: 40 190 02  
 E-Nummer: 79 813 89  
 Product numbers: 1000 0547

saas driver 500mA



saas driver 500mA  
 Sähkönumerot: 41 280 46  
 E-Nummer: 79 809 59  
 Product numbers: 1000 0546

saas driver one led



saas driver one led  
 Sähkönumerot: 41 281 18  
 E-Nummer: 74 513 84  
 Product numbers: 1000 0543

saas move



saas move  
 Sähkönumerot: 40 190 03  
 E-Nummer: 79 809 41  
 Product numbers: 1000 0656

LED 3W 350mA  
 LED 3W 900mA  
 LED 6W  
 DIM

|                         |   |     |    |   |
|-------------------------|---|-----|----|---|
| saas dim                | • | •** | •* | • |
| saas maxi dim           | • | •** | •* | • |
| saas driver             | • |     |    |   |
| saas dim R              | • |     |    | • |
| saas driver 500mA       |   |     | •  |   |
| saas driver one led     | • |     |    |   |
| saas dim bluetooth      | • | •** | •* | • |
| saas maxi dim bluetooth | • | •** | •* | • |
| saas dim TRIAC          | • |     | •* | • |
| saas move               | • |     |    |   |

\* Asetettava DIP-kytkin 500mA arvoon  
 \* Ställ in DIP-omkopplaren till 500mA  
 \* Set the DIP-switch to 500mA  
 \*\* Asetettava DIP-kytkin 900mA arvoon  
 \*\* Ställ in DIP-omkopplaren till 900mA  
 \*\* Set the DIP-switch to 900mA

saas dim / maxi dim / dim R

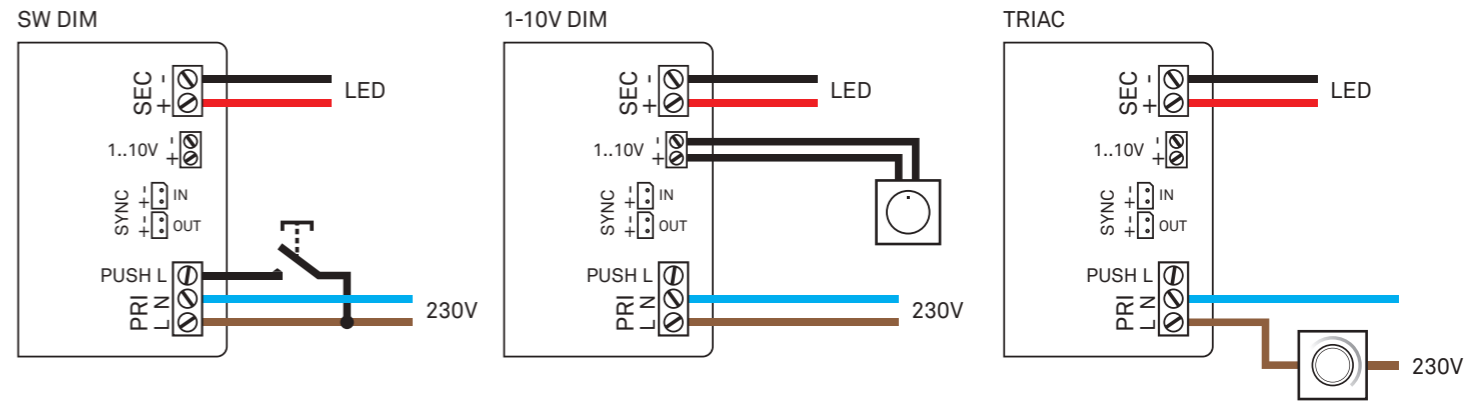

SW DIM

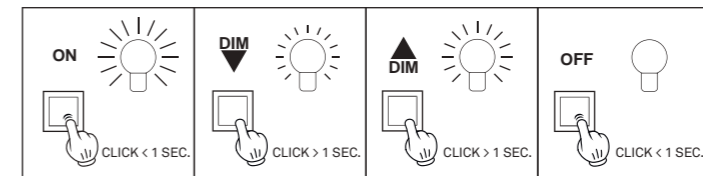

1-10V DIM

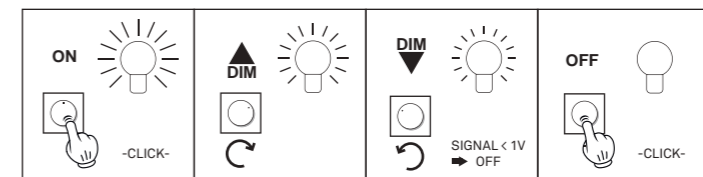



### saas wire 8



1-8 LED IP20 -30°C...+125°C

9,5 m

|              |           |                 |
|--------------|-----------|-----------------|
|              |           |                 |
| Sähkönumerot | E-Nummer  | Product numbers |
| 41 069 03    | 74 506 97 | 1000 0648       |

saas wire 8

### saas wire 12



1-12 LED IP20 -30°C...+125°C

19,0 m

|              |           |                 |
|--------------|-----------|-----------------|
|              |           |                 |
| Sähkönumerot | E-Nummer  | Product numbers |
| 41 280 61    | 74 508 62 | 1000 0650       |

saas wire 12

### saas wire 8 XS



1-8 LED IP20 -30°C...+125°C

3,8 m

|              |           |                 |
|--------------|-----------|-----------------|
|              |           |                 |
| Sähkönumerot | E-Nummer  | Product numbers |
| 41 281 13    | 74 508 86 | 1000 0646       |

saas wire 8 XS

### saas wire 16



1-16 LED IP20 -30°C...+125°C

25,0 m

|              |           |                 |
|--------------|-----------|-----------------|
|              |           |                 |
| Sähkönumerot | E-Nummer  | Product numbers |
| 41 280 62    | 74 508 63 | 1000 0649       |

saas wire 16

### saas wire 8 XL



1-8 LED IP20 -30°C...+125°C

16,5 m

|              |           |                 |
|--------------|-----------|-----------------|
|              |           |                 |
| Sähkönumerot | E-Nummer  | Product numbers |
| 41 280 60    | 74 508 61 | 1000 0647       |

saas wire 8 XL

### saas cable+



IP20 -30°C...+125°C

2,5 m / 5,0 m

|              |           |                 |
|--------------|-----------|-----------------|
|              |           |                 |
| Sähkönumerot | E-Nummer  | Product numbers |
| 41 069 31    | 74 526 96 | 1000 0662       |
| 41 314 04    | 74 514 43 | 1000 0661       |

saas cable+ 2,5 m  
saas cable+ 5,0 m

## saas loop

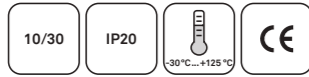

saas loop 10  
saas loop 30

|                 | Finland                | Sweden                 | EU                     |
|-----------------|------------------------|------------------------|------------------------|
| Sähkönumerot    | 41 280 63<br>41 280 64 | 74 508 64<br>74 508 65 | 1000 0658<br>1000 0657 |
| E-Nummer        |                        |                        |                        |
| Product numbers |                        |                        |                        |

## saas square

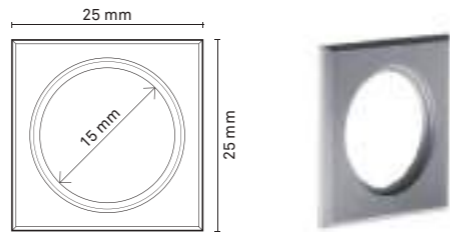

|                 | Finland  | Sweden   | EU   |
|-----------------|--|--|--|
| Sähkönumerot    | 41 069 23<br>41 280 23<br>41 280 21<br>41 280 22 | 74 526 97<br>74 507 98<br>74 507 96<br>74 507 97 | 1000 0655<br>1000 0652<br>1000 0654<br>1000 0653 |
| E-Nummer        |  |  |  |
| Product numbers |  |  |  |

## saas spot

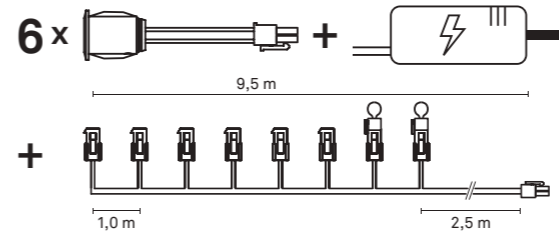
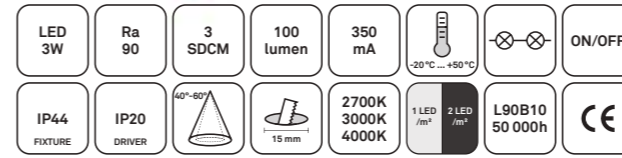

|       | Finland   | Sweden    | EU        |
|-------|-----------|-----------|-----------|
| 2700K |           |           | 1000 0711 |
| 3000K | 41 069 21 | 74 524 06 | 1000 0704 |
| 4000K | 41 069 47 | 74 507 74 | 1000 0703 |
| 2700K |           |           | 1000 0708 |
| 3000K | 41 280 12 | 74 507 79 | 1000 0705 |
| 4000K | 41 280 13 | 74 507 80 | 1000 0700 |
| 2700K |           |           | 1000 0710 |
| 3000K | 41 280 08 | 74 507 75 | 1000 0707 |
| 4000K | 41 280 09 | 74 507 76 | 1000 0702 |
| 2700K |           |           | 1000 0709 |
| 3000K | 41 280 10 | 74 507 77 | 1000 0706 |
| 4000K | 41 280 11 | 74 507 78 | 1000 0701 |

\*Also available in 2700K

## saas step

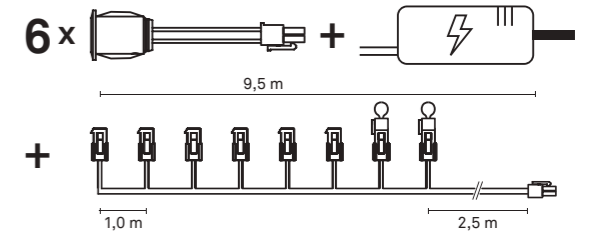
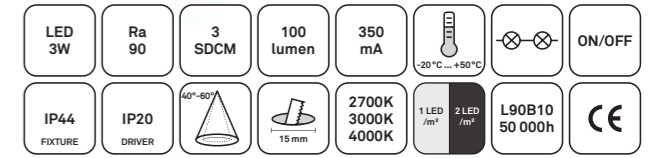

|       | Finland   | Sweden    | EU        |
|-------|-----------|-----------|-----------|
| 2700K |           |           | 1000 0699 |
| 3000K | 41 069 19 | 74 524 04 | 1000 0692 |
| 4000K | 41 069 45 | 74 507 60 | 1000 0691 |
| 2700K |           |           | 1000 0696 |
| 3000K | 41 069 93 | 74 507 65 | 1000 0693 |
| 4000K | 41 069 95 | 74 507 66 | 1000 0688 |
| 2700K |           |           | 1000 0698 |
| 3000K | 41 069 89 | 74 507 61 | 1000 0695 |
| 4000K | 41 069 90 | 74 507 62 | 1000 0690 |
| 2700K |           |           | 1000 0697 |
| 3000K | 41 069 91 | 74 507 63 | 1000 0694 |
| 4000K | 41 069 92 | 74 507 64 | 1000 0689 |

\*Also available in 2700K

## saas sauna

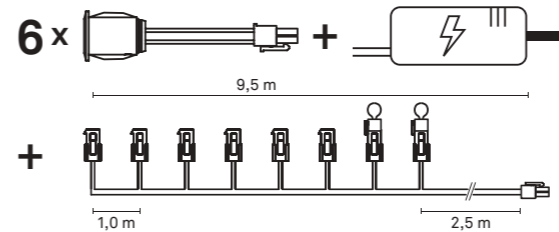
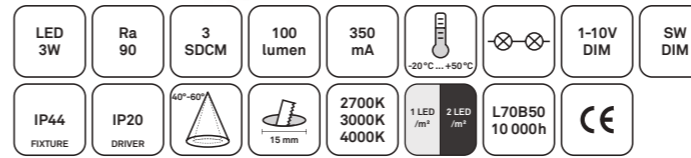

|       | Finland   | Sweden    | EU        |
|-------|-----------|-----------|-----------|
| 2700K |           |           | 1000 0720 |
| 3000K | 41 069 15 | 74 525 97 | 1000 0715 |
| 4000K | 41 069 41 | 74 507 36 | 1000 0714 |
| 2700K |           |           | 1000 0719 |
| 3000K | 41 069 49 | 74 507 37 | 1000 0717 |
| 4000K | 41 069 50 | 74 507 38 | 1000 0713 |
| 2700K |           |           | 1000 0718 |
| 3000K | 41 069 51 | 74 507 39 | 1000 0716 |
| 4000K | 41 069 52 | 74 507 40 | 1000 0712 |

\*Also available in 2700K



# LED STRIP

## A++

ENERGIATEHOKAS  
ENERGIEFFEKTIVA  
ENERGY EFFICIENT



## SUPERIOR

KORKEA VÄRINTOISTOINDEKSI  
HÖGT FÄRGÅTERGIVNINGINDEX  
HIGH COLOR RENDERING INDEX



## CREATIVE

VÄRI- JA TEHOSTEVALOT  
FÄRG- OCH EFFEKTLAMPOR  
COLORED AND EFFECT LIGHTS







saas strip pro A++ IP65

strip pro A++

**FIN** Ledvalonauha sisäkäyttöön tunnelmavalaisuksen luomiseen.  
**SWE** Led strip för inomhusbruk för att skapa stämningbelysning.  
**ENG** Led strip for indoor use for creating ambient lighting.

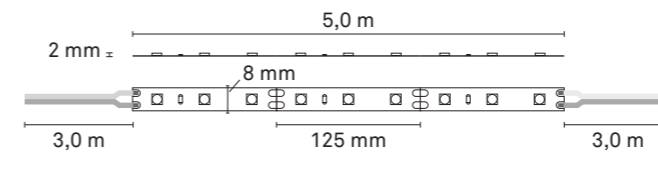

|              |            |     |          |                |                  |                          |     |
|--------------|------------|-----|----------|----------------|------------------|--------------------------|-----|
| 60 led/m     | LED 4,8W/m | 24V | 657 lm/m | Ra 85          | 3 SDCM           | IP20                     | DIM |
| 30°C...+50°C |            |     | 125 mm   | L90B10 50 000h | 5 YEARS WARRANTY | 60 mm MIN. BEND DIAMETER | CE  |

|                          | 🇫🇮 Sähkönumerot | 🇸🇪 E-Nummer | 🇪🇺 Product numbers |
|--------------------------|-----------------|-------------|--------------------|
| saas strip pro A++ 3000K | 41 333 27       | 75 076 38   | 1000 1693          |
| saas strip pro A++ 4000K | 41 333 28       | 75 076 39   | 1000 1694          |

strip pro A++ IP65

**FIN** Ledvalonauha ulko- ja sisäkäyttöön tunnelmavalaisuksen luomiseen.  
**SWE** Led strip för inom- och utomhusbruk för att skapa stämningbelysning.  
**ENG** Led strip for indoor and outdoor use for creating ambient lighting.

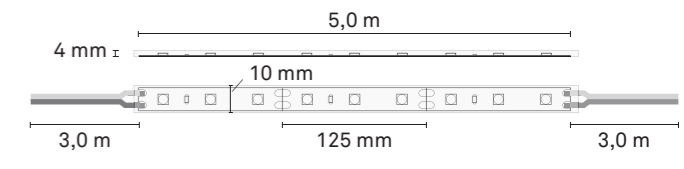

|              |            |     |          |                |                  |                          |     |
|--------------|------------|-----|----------|----------------|------------------|--------------------------|-----|
| 60 led/m     | LED 4,8W/m | 24V | 657 lm/m | Ra 85          | 3 SDCM           | IP65                     | DIM |
| 30°C...+50°C |            |     | 125 mm   | L90B10 50 000h | 5 YEARS WARRANTY | 60 mm MIN. BEND DIAMETER | CE  |

|                               | 🇫🇮 Sähkönumerot | 🇸🇪 E-Nummer | 🇪🇺 Product numbers |
|-------------------------------|-----------------|-------------|--------------------|
| saas strip pro A++ IP65 3000K | 41 333 29       | 75 076 40   | 1000 1696          |
| saas strip pro A++ IP65 4000K | 41 333 30       | 75 076 41   | 1000 1695          |

strip pro A++ IP65 NANO

**FIN** Ledvalonauha ulko- ja sisäkäyttöön tunnelmavalaisuksen luomiseen.  
**SWE** Led strip för inom- och utomhusbruk för att skapa stämningbelysning.  
**ENG** Led strip for indoor and outdoor use for creating ambient lighting.

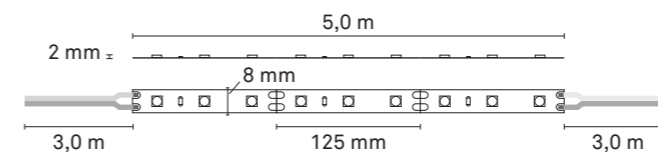

|          |              |     |          |                |                  |                          |      |
|----------|--------------|-----|----------|----------------|------------------|--------------------------|------|
| 60 led/m | LED 4,8W/m   | 24V | 657 lm/m | Ra 85          | 3 SDCM           | IP65                     | NANO |
| DIM      | 30°C...+50°C |     | 125 mm   | L90B10 50 000h | 5 YEARS WARRANTY | 60 mm MIN. BEND DIAMETER | CE   |

|                               | 🇫🇮 Sähkönumerot | 🇸🇪 E-Nummer | 🇪🇺 Product numbers |
|-------------------------------|-----------------|-------------|--------------------|
| saas strip pro A++ NANO 3000K | 41 333 31       | 75 076 42   | 1000 1697          |
| saas strip pro A++ NANO 4000K | 41 333 32       | 75 076 43   | 1000 1698          |





saas strip pro P A++

strip pro P A++

**FIN** Tehokas ledvalonauha sisäkäyttöön yleisvalaistuksen luomiseen.  
**SWE** Stark led strip för inomhusbruk för att skapa allmän belysning.  
**ENG** Powerful led strip for indoor use for creating general lighting.

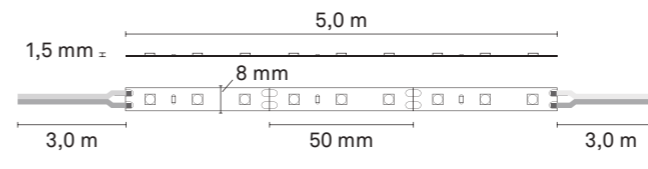

|               |           |                |                  |                          |           |      |     |
|---------------|-----------|----------------|------------------|--------------------------|-----------|------|-----|
| 160 led/m     | LED 12W/m | 24V            | 1660 lm/m        | Ra 85                    | 3 SDCM    | IP20 | DIM |
| -20°C...+50°C | 50 mm     | L90B10 50 000h | 5 YEARS WARRANTY | 60 mm MIN. BEND DIAMETER | ALUMINIUM |      |     |

CE

\*Lednauha on asennettava jäähdytysprofiiliin | Ljusband måste installera i profil | Led strip must be installed to cooling profile

|                            | Finland      | Sweden    | EU              |
|----------------------------|--------------|-----------|-----------------|
|                            | Sähkönumerot | E-Nummer  | Product numbers |
| saas strip pro P A++ 3000K | 41 333 33    | 75 076 44 | 1000 1704       |
| saas strip pro P A++ 4000K | 41 333 34    | 75 076 45 | 1000 1700       |

strip pro P A++ IP65 NANO

**FIN** Ledvalonauha ulko- ja sisäkäyttöön tunnelmavalaistuksen luomiseen.  
**SWE** Led strip för inom- och utomhusbruk för att skapa stämningbelysning.  
**ENG** Led strip for indoor and outdoor use for creating ambient lighting.

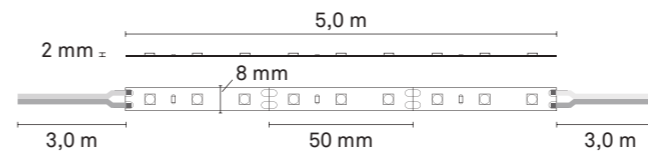

|               |           |                |                  |                          |           |      |      |
|---------------|-----------|----------------|------------------|--------------------------|-----------|------|------|
| 160 led/m     | LED 12W/m | 24V            | 1660 lm/m        | Ra 85                    | 3 SDCM    | IP65 | NANO |
| -20°C...+50°C | 100 mm    | L90B10 50 000h | 5 YEARS WARRANTY | 60 mm MIN. BEND DIAMETER | ALUMINIUM |      |      |

CE

|                                      | Finland      | Sweden    | EU              |
|--------------------------------------|--------------|-----------|-----------------|
|                                      | Sähkönumerot | E-Nummer  | Product numbers |
| saas strip pro P A++ IP65 NANO 3000K | 41 333 37    | 75 076 48 | 1000 1699       |
| saas strip pro P A++ IP65 NANO 4000K | 41 333 38    | 75 076 49 | 1000 1703       |

strip pro P A++ IP67

**FIN** Ledvalonauha ulko- ja sisäkäyttöön tunnelmavalaistuksen luomiseen.  
**SWE** Led strip för inom- och utomhusbruk för att skapa stämningbelysning.  
**ENG** Led strip for indoor and outdoor use for creating ambient lighting.

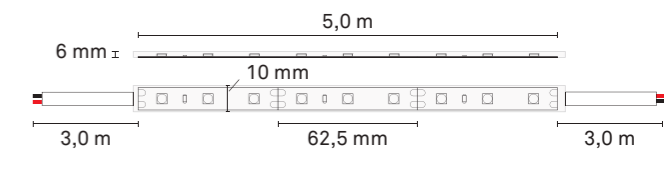

|               |            |                |                  |                          |           |      |     |
|---------------|------------|----------------|------------------|--------------------------|-----------|------|-----|
| 128 led/m     | LED 9,6W/m | 24V            | 1342 lm/m        | Ra 85                    | 3 SDCM    | IP67 | DIM |
| -20°C...+50°C | 62,5 mm    | L90B10 50 000h | 5 YEARS WARRANTY | 60 mm MIN. BEND DIAMETER | ALUMINIUM |      |     |

CE

\*Lednauha on asennettava jäähdytysprofiiliin | Ljusband måste installera i profil | Led strip must be installed to cooling profile

|                                 | Finland      | Sweden    | EU              |
|---------------------------------|--------------|-----------|-----------------|
|                                 | Sähkönumerot | E-Nummer  | Product numbers |
| saas strip pro P A++ IP67 3000K | 41 333 35    | 75 076 46 | 1000 1702       |
| saas strip pro P A++ IP67 4000K | 41 333 36    | 75 076 47 | 1000 1701       |





## strip pro SP A++

**FIN** Erittäin tehokas ledvalonauha sisäkäyttöön yleisvalaistuksen luomiseen.  
**SWE** Extra stark led strip för inomhusbruk för att skapa allmän belysning.  
**ENG** Very powerful led strip for indoor use for creating general lighting.

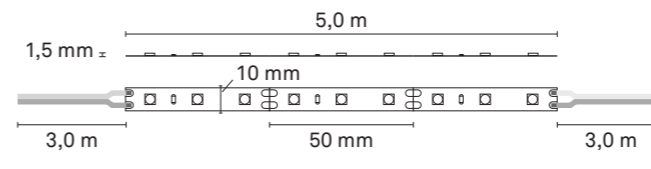

|               |           |                |                  |                          |             |      |     |
|---------------|-----------|----------------|------------------|--------------------------|-------------|------|-----|
| 160 led/m     | LED 18W/m | 24V            | 2400 lm/m        | Ra 85                    | 3 SDCM      | IP20 | DIM |
| -20°C...+50°C | 50 mm     | L90B10 50 000h | 5 YEARS WARRANTY | 60 mm MIN. BEND DIAMETER | * ALUMINIUM |      |     |
| CE            |           |                |                  |                          |             |      |     |

\*Lednauha on asennettava jäähdytysprofiiliin | Ljusband måste installera i profil | Led strip must be installed to cooling profile

|                             | Finland      | Sweden    | EU              |
|-----------------------------|--------------|-----------|-----------------|
|                             | Sähkönumerot | E-Nummer  | Product numbers |
| saas strip pro SP A++ 3000K | 41 333 39    | 75 076 50 | 1000 1705       |
| saas strip pro SP A++ 4000K | 41 333 40    | 75 076 51 | 1000 1706       |

## strip pro mini

**FIN** Ledvalonauha ulko- ja sisäkäyttöön tunnelmavalaistuksen luomiseen.  
**SWE** Led strip för inom- och utomhusbruk för att skapa stämningbelysning.  
**ENG** Led strip for indoor and outdoor use for creating ambient lighting.

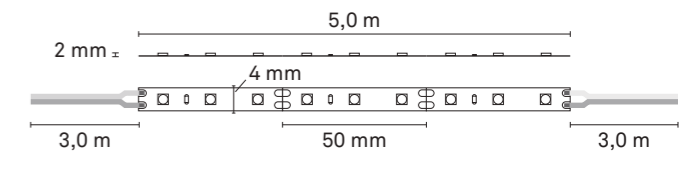

|               |            |                |                  |                          |             |      |     |
|---------------|------------|----------------|------------------|--------------------------|-------------|------|-----|
| 120 led/m     | LED 9,6W/m | 24V            | 600 lm/m         | Ra 85                    | 3 SDCM      | IP20 | DIM |
| -20°C...+50°C | 50 mm      | L90B10 50 000h | 5 YEARS WARRANTY | 60 mm MIN. BEND DIAMETER | * ALUMINIUM |      |     |
| CE            |            |                |                  |                          |             |      |     |

\*Lednauha on asennettava jäähdytysprofiiliin | Ljusband måste installera i profil | Led strip must be installed to cooling profile

|                           | Finland      | Sweden    | EU              |
|---------------------------|--------------|-----------|-----------------|
|                           | Sähkönumerot | E-Nummer  | Product numbers |
| saas strip pro mini 2700K | 41 314 15    | 75 052 81 | 1000 0584       |
| saas strip pro mini 3000K | 41 281 02    | 75 033 49 | 1000 0555       |
| saas strip pro mini 4000K | 41 281 03    | 75 033 50 | 1000 0554       |

## strip pro SP A++ IP65 NANO

**FIN** Erittäin tehokas ledvalonauha ulko- ja sisäkäyttöön yleisvalaistuksen luomiseen.  
**SWE** Extra stark led strip för inom- och utomhusbruk för att skapa allmän belysning.  
**ENG** Very powerful led strip for indoor and outdoor use for creating general lighting.

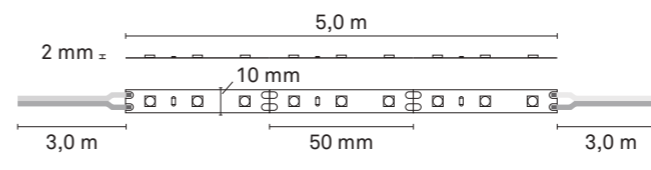

|           |               |       |                |                  |                          |             |      |
|-----------|---------------|-------|----------------|------------------|--------------------------|-------------|------|
| 160 led/m | LED 18W/m     | 24V   | 2400 lm/m      | Ra 85            | 3 SDCM                   | IP65        | NANO |
| DIM       | -20°C...+50°C | 50 mm | L90B10 50 000h | 5 YEARS WARRANTY | 60 mm MIN. BEND DIAMETER | * ALUMINIUM |      |
| CE        |               |       |                |                  |                          |             |      |

|                                       | Finland      | Sweden    | EU              |
|---------------------------------------|--------------|-----------|-----------------|
|                                       | Sähkönumerot | E-Nummer  | Product numbers |
| saas strip pro SP A++ IP65 NANO 3000K | 41 333 41    | 75 076 52 | 1000 1707       |
| saas strip pro SP A++ IP65 NANO 4000K | 41 333 42    | 75 076 53 | 1000 1708       |





## strip pro maxi

**FIN** Ledvalonauha 20 metrin kelalla sisäkäyttöön tunnelmavalaisuksen luomiseen. **SWE** Led strip i en 20 meter spole för inomhusbruk för stämningbelysning. **ENG** Led strip in a 20 meter spool for indoor use for creating ambient lighting.

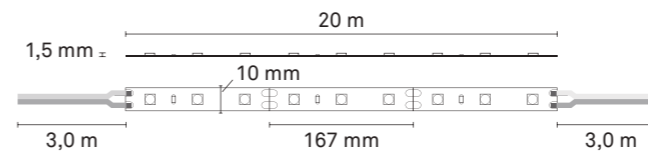

|               |            |        |          |                |                  |                          |     |
|---------------|------------|--------|----------|----------------|------------------|--------------------------|-----|
| 60 led/m      | LED 4,6W/m | 24V    | 385 lm/m | Ra 90          | 3 SDCM           | IP20                     | DIM |
| -30°C...+50°C |            | 167 mm |          | L90B10 50 000h | 5 YEARS WARRANTY | 60 mm MIN. BEND DIAMETER |     |

## strip pro maxi IP67

**FIN** Ledvalonauha 20 metrin kelalla ulko- ja sisäkäyttöön tunnelmavalaisuksen luomiseen. **SWE** Led strip i en 20 meter spole för inom- och utomhusbruk för stämningbelysning. **ENG** Led strip in a 20 meter spool for indoor and outdoor use for creating ambient lighting.

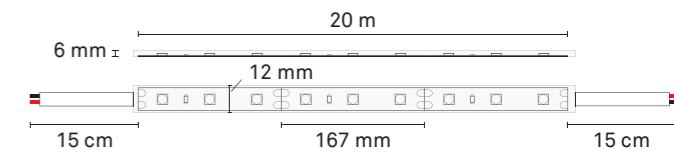

|               |            |        |          |                |                  |                          |     |
|---------------|------------|--------|----------|----------------|------------------|--------------------------|-----|
| 60 led/m      | LED 4,6W/m | 24V    | 385 lm/m | Ra 90          | 3 SDCM           | IP67                     | DIM |
| -30°C...+50°C |            | 167 mm |          | L90B10 50 000h | 5 YEARS WARRANTY | 60 mm MIN. BEND DIAMETER |     |





saas strip pro maxi P 3K

## strip pro maxi P

**FIN** Tehokas ledvalonauha 20 metrin kelalla sisäkäyttöön yleisvalaistuksen luomiseen. **SWE** Stark led strip i en 20 meter spole för inomhusbruk för allmän belysning. **ENG** Powerful led strip in a 20 meter spool for indoor use for creating general lighting.

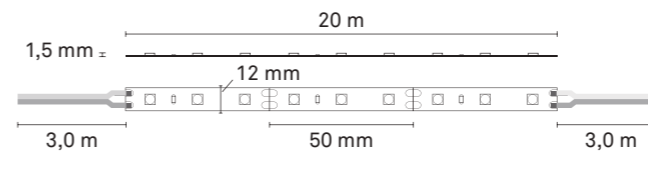

|               |            |       |           |                |                  |                          |     |
|---------------|------------|-------|-----------|----------------|------------------|--------------------------|-----|
| 120 led/m     | LED 9,6W/m | 24V   | 1360 lm/m | Ra 90          | 3 SDCM           | IP20                     | DIM |
| -30°C...+50°C |            | 50 mm |           | L90B10 50 000h | 5 YEARS WARRANTY | 60 mm MIN. BEND DIAMETER |     |
| CE            |            |       |           |                |                  |                          |     |

\*Lednauha on asennettava jäähdytysprofiiliin | Ljusband måste installera i profil | Led strip must be installed to cooling profile

## strip pro maxi P IP67

**FIN** Ledvalonauha 20 metrin kelalla ulko- ja sisäkäyttöön yleisvalaistuksen luomiseen. **SWE** Led strip i en 20 meter spole för inom- och utomhusbruk för allmän belysning. **ENG** Led strip in a 20 meter spool for indoor and outdoor use for creating general lighting.

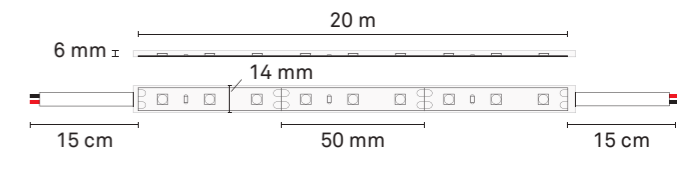

|               |            |       |          |                |                  |                          |     |
|---------------|------------|-------|----------|----------------|------------------|--------------------------|-----|
| 120 led/m     | LED 9,6W/m | 24V   | 990 lm/m | Ra 90          | 3 SDCM           | IP67                     | DIM |
| -30°C...+50°C |            | 50 mm |          | L90B10 50 000h | 5 YEARS WARRANTY | 60 mm MIN. BEND DIAMETER |     |
| CE            |            |       |          |                |                  |                          |     |

\*Lednauha on asennettava jäähdytysprofiiliin | Ljusband måste installera i profil | Led strip must be installed to cooling profile

Sähkönumerot  
 E-Nummer  
 Product numbers

saas strip pro maxi P 3000K  
 saas strip pro maxi P 4000K

41 281 73  
 41 281 74  
 75 051 91  
 75 051 92  
 1000 0557  
 1000 0556

Sähkönumerot  
 E-Nummer  
 Product numbers

saas strip pro maxi P IP67 3000K  
 saas strip pro maxi P IP67 4000K

41 333 86  
 41 333 87  
 1000 1975  
 1000 1976





saas strip pro P A++ 2700K

## strip pro 3K A++ 50M

**FIN** Ledvalonauha 50 metrin kelassa. Voit kätevästi katkaista yhdestä kelasta useita lyhyempiä mittoja, enimmäispituus 10 metriä. **SWE** Ledband i en 50 meters spole. Det går lätt att göra flera kortare längder från denna spole, max längd för varje enskilt ledband är 10 meter. **ENG** Led strip in a 50 meter spool. From this roll it's easy to cut several shorter lengths, maximum length for each led strip is 10 meters.

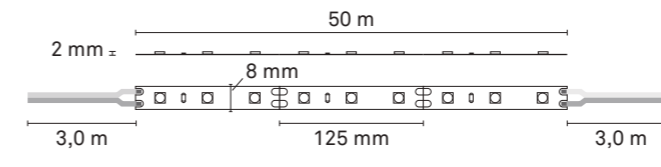

|               |            |     |          |                |                  |                          |     |
|---------------|------------|-----|----------|----------------|------------------|--------------------------|-----|
| 64 led/m      | LED 4,8W/m | 24V | 657 lm/m | Ra 85          | 3 SDCM           | IP20                     | DIM |
| -20°C...+50°C |            |     |          | L90B10 50 000h | 5 YEARS WARRANTY | 60 mm MIN. BEND DIAMETER | CE  |

saas strip pro 3K A++ 50M

|              |          |                 |
|--------------|----------|-----------------|
|              |          |                 |
| Sähkönumerot | E-Nummer | Product numbers |
| 41 333 92    |          | 1000 2412       |

## strip pro P 3K A++ 50M

**FIN** Ledvalonauha 50 metrin kelassa. Voit kätevästi katkaista yhdestä kelasta useita lyhyempiä mittoja, enimmäispituus 10 metriä. **SWE** Ledband i en 50 meters spole. Det går lätt att göra flera kortare längder från denna spole, max längd för varje enskilt ledband är 10 meter. **ENG** Led strip in a 50 meter spool. From this roll it's easy to cut several shorter lengths, maximum length for each led strip is 10 meters.

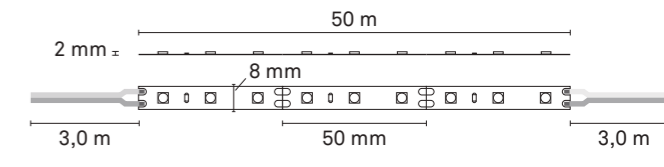

|               |           |     |           |                |                  |                          |     |
|---------------|-----------|-----|-----------|----------------|------------------|--------------------------|-----|
| 160 led/m     | LED 12W/m | 24V | 1712 lm/m | Ra 85          | 3 SDCM           | IP20                     | DIM |
| -20°C...+50°C |           |     |           | L90B10 50 000h | 5 YEARS WARRANTY | 60 mm MIN. BEND DIAMETER | CE* |

\*Lednauha on asennettava jäähdytysprofiiliin | Ljusband måste installera i profil | Led strip must be installed to cooling profile

saas strip pro P3K A++ 50M

|              |          |                 |
|--------------|----------|-----------------|
|              |          |                 |
| Sähkönumerot | E-Nummer | Product numbers |
| 41 333 95    |          | 1000 2415       |

## strip pro 4K A++ 50M

**FIN** Ledvalonauha 50 metrin kelassa. Voit kätevästi katkaista yhdestä kelasta useita lyhyempiä mittoja, enimmäispituus 10 metriä. **SWE** Ledband i en 50 meters spole. Det går lätt att göra flera kortare längder från denna spole, max längd för varje enskilt ledband är 10 meter. **ENG** Led strip in a 50 meter spool. From this roll it's easy to cut several shorter lengths, maximum length for each led strip is 10 meters.

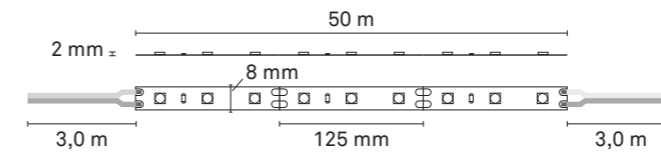

|               |            |     |          |                |                  |                          |     |
|---------------|------------|-----|----------|----------------|------------------|--------------------------|-----|
| 64 led/m      | LED 4,8W/m | 24V | 657 lm/m | Ra 85          | 3 SDCM           | IP20                     | DIM |
| -20°C...+50°C |            |     |          | L90B10 50 000h | 5 YEARS WARRANTY | 60 mm MIN. BEND DIAMETER | CE  |

saas strip pro 4K A++ 50M

|              |          |                 |
|--------------|----------|-----------------|
|              |          |                 |
| Sähkönumerot | E-Nummer | Product numbers |
| 41 333 93    |          | 1000 2413       |

## strip pro P 4K A++ 50M

**FIN** Ledvalonauha 50 metrin kelassa. Voit kätevästi katkaista yhdestä kelasta useita lyhyempiä mittoja, enimmäispituus 10 metriä. **SWE** Ledband i en 50 meters spole. Det går lätt att göra flera kortare längder från denna spole, max längd för varje enskilt ledband är 10 meter. **ENG** Led strip in a 50 meter spool. From this roll it's easy to cut several shorter lengths, maximum length for each led strip is 10 meters.

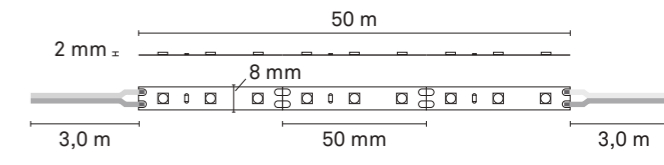

|               |           |     |           |                |                  |                          |     |
|---------------|-----------|-----|-----------|----------------|------------------|--------------------------|-----|
| 160 led/m     | LED 12W/m | 24V | 1712 lm/m | Ra 85          | 3 SDCM           | IP20                     | DIM |
| -20°C...+50°C |           |     |           | L90B10 50 000h | 5 YEARS WARRANTY | 60 mm MIN. BEND DIAMETER | CE* |

\*Lednauha on asennettava jäähdytysprofiiliin | Ljusband måste installera i profil | Led strip must be installed to cooling profile

saas strip pro P4K A++ 50M

|              |          |                 |
|--------------|----------|-----------------|
|              |          |                 |
| Sähkönumerot | E-Nummer | Product numbers |
| 41 333 94    |          | 1000 2414       |





## quick W-to-S

**FIN** 8 tai 10 mm:n ledvalonauhalle soveltuva strip-ruuviiliitin, kun halutaan välttää juottaminen tai valita mieluinen johto. **SWE** Skruvterminal lämplig för 8 eller 10 mm led-ljusband, när du vill undvika lödning eller välja önskad kabel. **ENG** A strip screw connector suitable for 8 or 10 mm led light strips, when you want to avoid soldering or choose the desired cable.



saas quick W-to-S 8 mm:

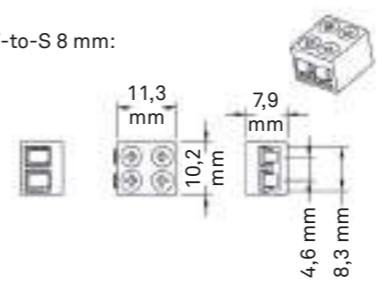

saas quick W-to-S 10 mm:

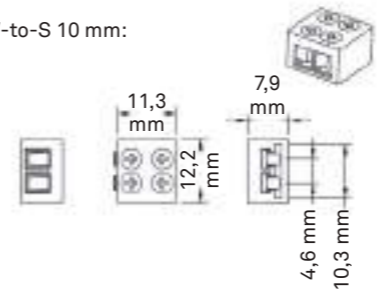

IP20    5 pieces / bag    cable 0,5-1,5 mm<sup>2</sup>:n

## quick S-to-S

**FIN** 8 ja 10 mm:n ledvalonauhalle tarkoitettu ruuviiliitos, kun halutaan yhdistää useita ledvalonauhoja juottamatta toisiinsa. **SWE** Skruvterminal avsedd för 8 och 10 mm led-ljusband, när man vill koppla ihop flera led-ljuslister utan lödning till varandra. **ENG** Screw connection intended for 8 and 10 mm led light strips, when you want to connect several led light strips without soldering to each other.



saas quick S-to-S 8 mm:

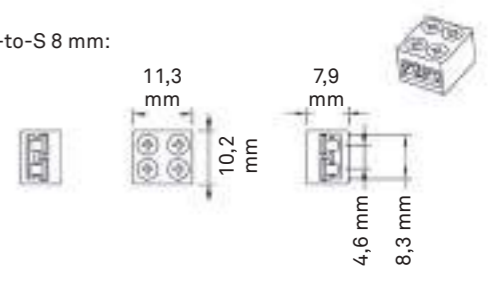

saas quick S-to-S 10 mm:

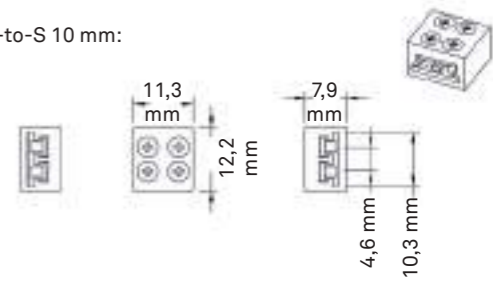

IP20    5 pieces / bag





saas strip pro superior

## strip pro superior

**FIN** Ledvalonauha sisäkäyttöön tunnelmavalaisuksen luomiseen.  
**SWE** Led strip för inomhusbruk för att skapa stämningbelysning.  
**ENG** Led strip for indoor use for creating ambient lighting.

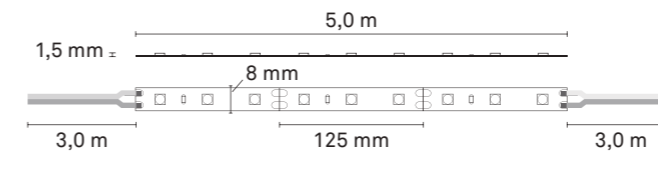

|                 |            |            |          |                |                  |                          |     |
|-----------------|------------|------------|----------|----------------|------------------|--------------------------|-----|
| 64 led/m        | LED 4,8W/m | 24V        | 460 lm/m | Ra 95          | 3 SDCM           | IP20                     | DIM |
| [-20°C...+50°C] | [Circuit]  | [Scissors] | [Bend]   | L90B10 50 000h | 5 YEARS WARRANTY | 60 mm MIN. BEND DIAMETER | CE  |

|                               | 🇫🇮 Sähkönumerot | 🇸🇪 E-Nummer | 🇪🇺 Product numbers |
|-------------------------------|-----------------|-------------|--------------------|
| saas strip pro superior 2700K | 41 333 43       | 75 076 54   | 1000 1714          |
| saas strip pro superior 3000K | 41 333 44       | 75 076 55   | 1000 1712          |
| saas strip pro superior 4000K | 41 333 45       | 75 076 56   | 1000 1713          |

## strip pro superior IP67

**FIN** Ledvalonauha ulko- ja sisäkäyttöön tunnelmavalaisuksen luomiseen.  
**SWE** Led strip för inom- och utomhusbruk för att skapa stämningbelysning.  
**ENG** Led strip for indoor and outdoor use for creating ambient lighting.

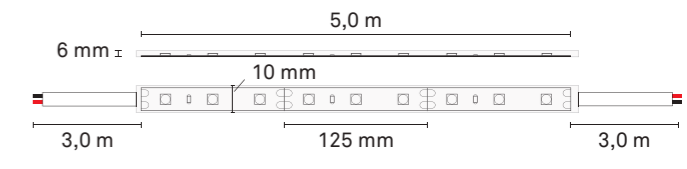

|                 |            |            |          |                |                  |                          |     |
|-----------------|------------|------------|----------|----------------|------------------|--------------------------|-----|
| 64 led/m        | LED 4,8W/m | 24V        | 460 lm/m | Ra 95          | 3 SDCM           | IP67                     | DIM |
| [-20°C...+50°C] | [Circuit]  | [Scissors] | [Bend]   | L90B10 50 000h | 5 YEARS WARRANTY | 60 mm MIN. BEND DIAMETER | CE  |

|                                    | 🇫🇮 Sähkönumerot | 🇸🇪 E-Nummer | 🇪🇺 Product numbers |
|------------------------------------|-----------------|-------------|--------------------|
| saas strip pro superior IP67 2700K | 41 333 46       | 75 076 57   | 1000 1717          |
| saas strip pro superior IP67 3000K | 41 333 47       | 75 076 58   | 1000 1715          |
| saas strip pro superior IP67 4000K | 41 333 48       | 75 076 59   | 1000 1716          |

SUPERIOR

## strip pro superior IP65 NANO

**FIN** Ledvalonauha ulko- ja sisäkäyttöön tunnelmavalaisuksen luomiseen.  
**SWE** Led strip för inom- och utomhusbruk för att skapa stämningbelysning.  
**ENG** Led strip for indoor and outdoor use for creating ambient lighting.

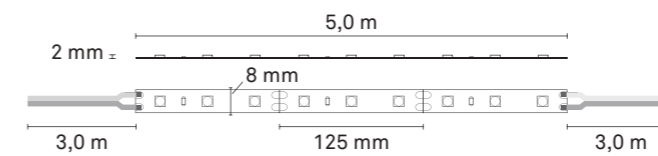

|              |                 |           |            |        |                |                  |                          |
|--------------|-----------------|-----------|------------|--------|----------------|------------------|--------------------------|
| 64 led/m     | LED 4,8W/m      | 24V       | 460 lm/m   | Ra 95  | 3 SDCM         | IP65             | NANO                     |
| DIM          | [-20°C...+50°C] | [Circuit] | [Scissors] | [Bend] | L90B10 50 000h | 5 YEARS WARRANTY | 60 mm MIN. BEND DIAMETER |
| [Waterproof] | CE              |           |            |        |                |                  |                          |

|   | 🇫🇮 Sähkönumerot | 🇸🇪 E-Nummer | 🇪🇺 Product numbers |
|---|-----------------|-------------|--------------------|
| saas strip pro superior IP65 NANO 2700K | 41 333 49       | 75 076 60   | 1000 1719          |
| saas strip pro superior IP65 NANO 3000K | 41 333 50       | 75 076 61   | 1000 1720          |
| saas strip pro superior IP65 NANO 4000K | 41 333 51       | 75 076 62   | 1000 1721          |





saas strip pro superior P

## strip pro superior P

**FIN** Tehokas ledvalonauha sisäkäyttöön yleisvalaistuksen luomiseen.  
**SWE** Stark led strip för inomhusbruk för att skapa allmän belysning.  
**ENG** Powerful led strip for indoor use for creating general lighting.

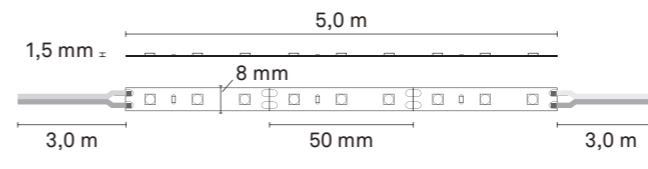

|               |           |                |                  |                          |        |      |     |
|---------------|-----------|----------------|------------------|--------------------------|--------|------|-----|
| 160 led/m     | LED 12W/m | 24V            | 1160 lm/m        | Ra 95                    | 3 SDCM | IP20 | DIM |
| -20°C...+50°C | 50 mm     | L90B10 50 000h | 5 YEARS WARRANTY | 60 mm MIN. BEND DIAMETER | *      |      |     |
| CE            |           |                |                  |                          |        |      |     |

\*Lednauha on asennettava jäähdytysprofiiliin | Ljusband måste installera i profil | Led strip must be installed to cooling profile

|                                 | 🇫🇮 Sähkönumerot | 🇸🇪 E-Nummer | 🇪🇺 Product numbers |
|---------------------------------|-----------------|-------------|--------------------|
| saas strip pro superior P 2700K | 41 333 52       | 75 076 63   | 1000 1723          |
| saas strip pro superior P 3000K | 41 333 53       | 75 076 64   | 1000 1718          |
| saas strip pro superior P 4000K | 41 333 54       |             | 1000 1722          |

## strip pro superior P IP65 NANO

**FIN** Tehokas ledvalonauha ulko- ja sisäkäyttöön yleisvalaistuksen luomiseen.  
**SWE** Stark led strip för inom- och utomhusbruk för att skapa allmän belysning.  
**ENG** Powerful led strip for indoor and outdoor use for creating general lighting.

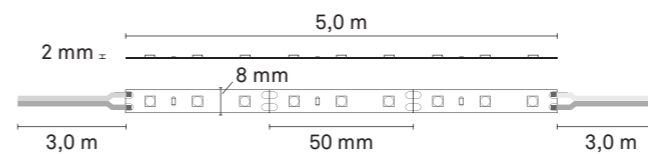

|           |               |       |                |                  |                          |      |      |
|-----------|---------------|-------|----------------|------------------|--------------------------|------|------|
| 160 led/m | LED 12W/m     | 24V   | 1160 lm/m      | Ra 95            | 3 SDCM                   | IP65 | NANO |
| DIM       | -20°C...+50°C | 50 mm | L90B10 50 000h | 5 YEARS WARRANTY | 60 mm MIN. BEND DIAMETER | *    |      |
| CE        |               |       |                |                  |                          |      |      |

\*Lednauha on asennettava jäähdytysprofiiliin | Ljusband måste installera i profil | Led strip must be installed to cooling profile

|   | 🇫🇮 Sähkönumerot | 🇸🇪 E-Nummer | 🇪🇺 Product numbers |
|---|-----------------|-------------|--------------------|
| saas strip pro superior P IP65 NANO 2700K | 41 333 58       | 75 076 68   | 1000 1725          |
| saas strip pro superior P IP65 NANO 3000K | 41 333 59       | 75 076 69   | 1000 1727          |
| saas strip pro superior P IP65 NANO 4000K | 41 333 60       | 75 076 70   | 1000 1728          |

## strip pro superior P IP67

**FIN** Tehokas ledvalonauha ulko- ja sisäkäyttöön yleisvalaistuksen luomiseen.  
**SWE** Stark led strip för inom- och utomhusbruk för att skapa allmän belysning.  
**ENG** Powerful led strip for indoor and outdoor use for creating general lighting.

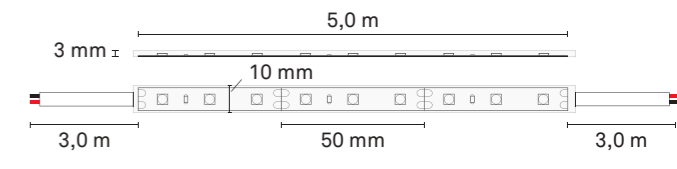

|               |            |                |                  |                          |        |      |     |
|---------------|------------|----------------|------------------|--------------------------|--------|------|-----|
| 128 led/m     | LED 9,6W/m | 24V            | 940 lm/m         | Ra 95                    | 3 SDCM | IP67 | DIM |
| -20°C...+50°C | 50 mm      | L90B10 50 000h | 5 YEARS WARRANTY | 60 mm MIN. BEND DIAMETER | *      |      |     |
| CE            |            |                |                  |                          |        |      |     |

\*Lednauha on asennettava jäähdytysprofiiliin | Ljusband måste installera i profil | Led strip must be installed to cooling profile

|                                      | 🇫🇮 Sähkönumerot | 🇸🇪 E-Nummer | 🇪🇺 Product numbers |
|--------------------------------------|-----------------|-------------|--------------------|
| saas strip pro superior P IP67 2700K | 41 333 55       | 75 076 65   | 1000 1724          |
| saas strip pro superior P IP67 3000K | 41 333 56       | 75 076 66   | 1000 1726          |
| saas strip pro superior P IP67 4000K | 41 333 57       | 75 076 67   | 1000 1729          |



## strip pro superior SP

**FIN** Erittäin tehokas ledvalonauha sisäkäyttöön yleisvalaistuksen luomiseen. **SWE** Extra stark led strip för inomhusbruk för att skapa allmän belysning. **ENG** Very powerful led strip for indoor use for creating general lighting.

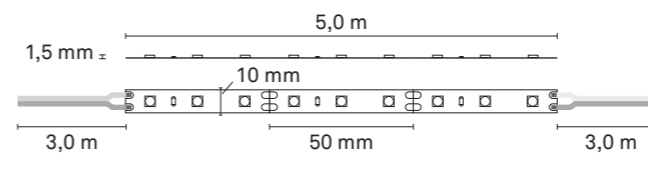

|                 |           |                |                  |                          |        |      |     |
|-----------------|-----------|----------------|------------------|--------------------------|--------|------|-----|
| 160 led/m       | LED 18W/m | 24V            | 1800 lm/m        | Ra 95                    | 3 SDCM | IP20 | DIM |
| -20°C ... +50°C | 50 mm     | L90B10 50 000h | 5 YEARS WARRANTY | 60 mm MIN. BEND DIAMETER |        |      |     |
|                 |           |                |                  |                          |        |      |     |

\*Lednauha on asennettava jäähdytysprofiiliin | Ljusband måste installera i profil | Led strip must be installed to cooling profile

|                                  | Sähkönumerot | E-Nummer  | Product numbers |
|----------------------------------|--------------|-----------|-----------------|
| saas strip pro superior SP 2700K | 41 333 61    | 75 076 71 | 1000 1730       |
| saas strip pro superior SP 3000K | 41 333 62    | 75 076 72 | 1000 1732       |
| saas strip pro superior SP 4000K | 41 333 63    | 75 076 73 | 1000 1733       |

## superior SP IP65 NANO

**FIN** Erittäin tehokas ledvalonauha sisä- ja ulkokäyttöön yleisvalaistuksen luomiseen. **SWE** Extra stark led strip för inom- och utomhusbruk för att skapa allmän belysning. **ENG** Very powerful led strip for indoor and outdoor use for creating general lighting.

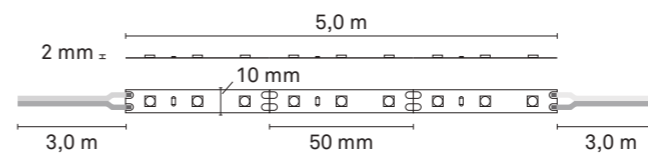

|           |                 |       |                |                  |                          |      |      |
|-----------|-----------------|-------|----------------|------------------|--------------------------|------|------|
| 160 led/m | LED 18W/m       | 24V   | 1800 lm/m      | Ra 95            | 3 SDCM                   | IP65 | NANO |
| DIM       | -20°C ... +50°C | 50 mm | L90B10 50 000h | 5 YEARS WARRANTY | 60 mm MIN. BEND DIAMETER |      |      |
|           |                 |       |                |                  |                          |      |      |

\*Lednauha on asennettava jäähdytysprofiiliin | Ljusband måste installera i profil | Led strip must be installed to cooling profile

|  | Sähkönumerot | E-Nummer  | Product numbers |
|--|--------------|-----------|-----------------|
| saas strip pro superior SP IP65 NANO 2700K | 41 333 64    | 75 076 74 | 1000 1731       |
| saas strip pro superior SP IP65 NANO 3000K | 41 333 65    | 75 076 75 | 1000 1734       |
| saas strip pro superior SP IP65 NANO 4000K | 41 333 66    | 75 076 76 | 1000 1735       |



saas strip pro dynamic

## creative shortcut P

**FIN** Ledvalonauha, joka on lyhennettävissä 16,66 mm välein. **SWE** Led strip med 16,66 mm skärintervall. **ENG** Led strip with 16,66 mm cutting interval.

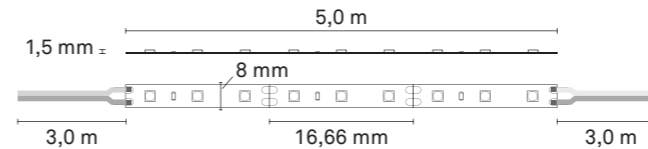

|                 |   |     |           |                |                  |                          |     |
|-----------------|---|-----|-----------|----------------|------------------|--------------------------|-----|
| 120 led/m       | LED 14,4W/m   | 24V | 1400 lm/m | Ra 85          | 3 SDCM           | IP20                     | DIM |
| -20°C ... +50°C |   |     |           | L90B10 50 000h | 5 YEARS WARRANTY | 60 mm MIN. BEND DIAMETER |     |
|                 | *Lednauha on asennettava jäähdytysprofiiliin   Ljusband måste installera i profil<br>Led strip must be installed to cooling profile |     |           |                |                  |                          |     |

|                                | Sähkönumerot | E-Nummer  | Product numbers |
|--------------------------------|--------------|-----------|-----------------|
| saas creative shortcut P 2700K | 41 333 69    | 75 076 79 | 1000 1736       |
| saas creative shortcut P 3000K | 41 333 70    | 75 076 80 | 1000 1742       |
| saas creative shortcut P 4000K | 41 333 71    | 75 076 81 | 1000 1737       |

## strip pro dynamic

**FIN** Ledvalonauha, jonka värielämpötilä on säädettävissä. **SWE** Led strip med justerbar färgtemperatur. **ENG** Led strip with adjustable color temperature.

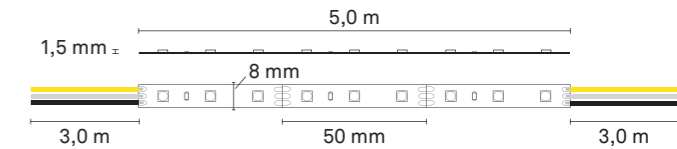

|                 |   |     |           |                |                  |                          |     |
|-----------------|---|-----|-----------|----------------|------------------|--------------------------|-----|
| 240 led/m       | LED 19,2W/m   | 24V | 1300 lm/m | Ra 90          | 3 SDCM           | IP20                     | DIM |
| -20°C ... +50°C |   |     |           | L90B10 50 000h | 5 YEARS WARRANTY | 60 mm MIN. BEND DIAMETER |     |
|                 | *Lednauha on asennettava jäähdytysprofiiliin   Ljusband måste installera i profil<br>Led strip must be installed to cooling profile |     |           |                |                  |                          |     |

|                        | Sähkönumerot | E-Nummer | Product numbers |
|------------------------|--------------|----------|-----------------|
| saas strip pro dynamic | 41 314 16    |          | 1000 0567       |

## shortcut P IP65 NANO

**FIN** Sisä- ja ulkokäyttöön soveltuva ledvalonauha 16,66 mm katkaisuvälein. **SWE** Led strip för inom- och utomhusbruk med 16,66 mm skärintervall. **ENG** Led strip for indoor and outdoor use with 16,66 mm cutting interval.

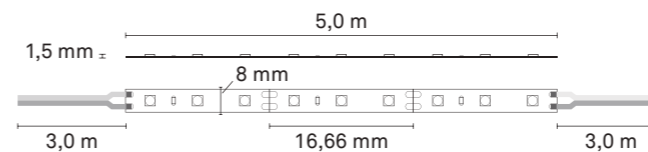

|                 |   |     |           |                |                  |                          |     |
|-----------------|---|-----|-----------|----------------|------------------|--------------------------|-----|
| 120 led/m       | LED 14,4W/m   | 24V | 1400 lm/m | Ra 85          | 3 SDCM           | IP65                     | DIM |
| -20°C ... +50°C |   |     |           | L90B10 50 000h | 5 YEARS WARRANTY | 60 mm MIN. BEND DIAMETER |     |
|                 | *Lednauha on asennettava jäähdytysprofiiliin   Ljusband måste installera i profil<br>Led strip must be installed to cooling profile |     |           |                |                  |                          |     |

|  | Sähkönumerot | E-Nummer  | Product numbers |
|--|--------------|-----------|-----------------|
| saas creative shortcut P IP65 NANO 2700K | 41 333 72    | 75 076 82 | 1000 1748       |
| saas creative shortcut P IP65 NANO 3000K | 41 333 73    | 75 076 83 | 1000 1740       |
| saas creative shortcut P IP65 NANO 4000K | 41 333 74    | 75 076 84 | 1000 1741       |

## creative DIM to WARM

**FIN** Ledvalonauha sisäkäyttöön. Himmennettäessä värisävy muuttuu lämpimämmäksi. **SWE** Ledband för inomhusbruk. Då ljuset dimmas blir färgtemperaturen varmare. **ENG** Led strip for indoor use. When the light is dimmed, the color temperature becomes warmer.

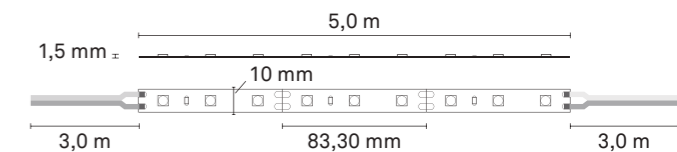

|                 |   |     |           |                |                  |                          |     |
|-----------------|---|-----|-----------|----------------|------------------|--------------------------|-----|
| 168 led/m       | LED 14,4W/m   | 24V | 1150 lm/m | Ra 90          | 3 SDCM           | IP20                     | DIM |
| -20°C ... +50°C |   |     |           | L90B10 50 000h | 5 YEARS WARRANTY | 60 mm MIN. BEND DIAMETER |     |
|                 | *Lednauha on asennettava jäähdytysprofiiliin   Ljusband måste installera i profil<br>Led strip must be installed to cooling profile |     |           |                |                  |                          |     |

|                           | Sähkönumerot | E-Nummer | Product numbers |
|---------------------------|--------------|----------|-----------------|
| saas creative DIM to WARM | 41 333 88    |          | 1000 2038       |





saas creative side view

## creative top view

**FIN** Päältä valaiseva lednauha sisä- ja ulkokäyttöön. **SWE** Utomhusbelyst LED-band för användning inomhus och utomhus. **ENG** Top side illuminating LED strip for indoor and outdoor use.

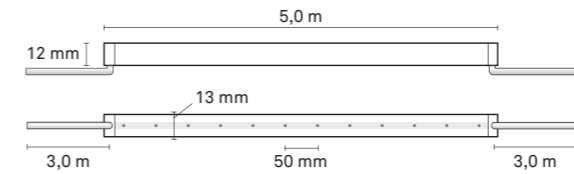

|                                   |              |                      |                |                  |                          |     |              |
|-----------------------------------|--------------|----------------------|----------------|------------------|--------------------------|-----|--------------|
| LED 9,6W/m                        | 24V          | 640 lm/m             | Ra 85          | 3 SDCM           | IP67                     | DIM | 15 x BRACKET |
| Temperature icon: -20°C ... +50°C | Circuit icon | Scissors icon: 50 mm | L90B10 50 000h | 5 YEARS WARRANTY | 60 mm MIN. BEND DIAMETER | CE  |              |

|                              | Finland      | Sweden    | Europe          |
|------------------------------|--------------|-----------|-----------------|
|                              | Sähkönumerot | E-Nummer  | Product numbers |
| saas creative top view 2700K | 41 314 17    | 75 076 25 | 1000 1673       |
| saas creative top view 3000K | 41 314 21    | 75 076 29 | 1000 1677       |
| saas creative top view 4000K | 41 314 19    | 75 076 27 | 1000 1675       |
| saas creative top view B     | 41 314 18    | 75 076 26 | 1000 1674       |
| saas creative top view R     | 41 314 20    | 75 076 28 | 1000 1676       |

## creative top 06x06

**FIN** Pienikokoinen joustava ledvalonauha täysin tasaisella valopinnalla. **SWE** Till storleken litet och flexibelt ledband med en helt jämn ljusyta. **ENG** A small and flexible led strip with a completely even light surface.

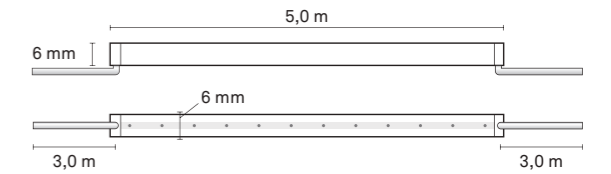

|                                   |              |                      |                |                  |                          |     |  |
|-----------------------------------|--------------|----------------------|----------------|------------------|--------------------------|-----|--|
| LED 8W/m                          | 24V          | 450 lm/m             | Ra 90          | 3 SDCM           | IP65                     | DIM |  |
| Temperature icon: -20°C ... +50°C | Circuit icon | Scissors icon: 50 mm | L90B10 50 000h | 5 YEARS WARRANTY | 60 mm MIN. BEND DIAMETER | CE  |  |

|                               | Finland      | Sweden   | Europe          |
|-------------------------------|--------------|----------|-----------------|
|                               | Sähkönumerot | E-Nummer | Product numbers |
| saas creative top 06x06 2700K | 41 333 91    |          | 1000 2391       |
| saas creative top 06x06 3000K | 41 333 89    |          | 1000 2392       |
| saas creative top 06x06 4000K | 41 333 90    |          | 1000 2393       |

## creative side view

**FIN** Sivulta valaiseva lednauha sisä- ja ulkokäyttöön. **SWE** Sidoljusande LED-remsa för användning inomhus och utomhus. **ENG** Side-illuminating LED strip for indoor and outdoor use.

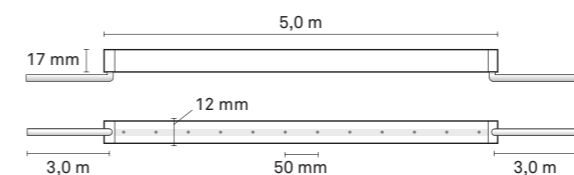
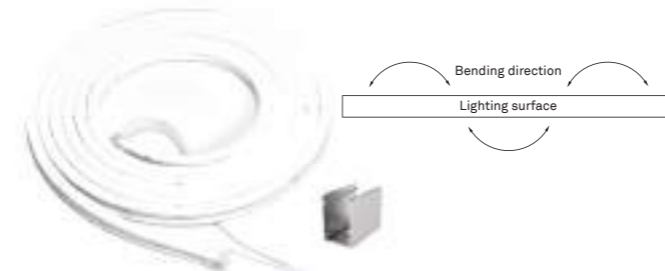

|                                   |              |                      |                |                  |                          |     |              |
|-----------------------------------|--------------|----------------------|----------------|------------------|--------------------------|-----|--------------|
| LED 9,6W/m                        | 24V          | 520 lm/m             | Ra 85          | 3 SDCM           | IP67                     | DIM | 15 x BRACKET |
| Temperature icon: -20°C ... +50°C | Circuit icon | Scissors icon: 50 mm | L90B10 50 000h | 5 YEARS WARRANTY | 60 mm MIN. BEND DIAMETER | CE  |              |

|                               | Finland      | Sweden    | Europe          |
|-------------------------------|--------------|-----------|-----------------|
|                               | Sähkönumerot | E-Nummer  | Product numbers |
| saas creative side view 2700K | 41 314 22    | 75 076 30 | 1000 1672       |
| saas creative side view 3000K | 41 314 23    | 75 076 31 | 1000 1678       |
| saas creative side view 4000K | 41 314 24    | 75 076 32 | 1000 1679       |
| saas creative side view B     | 41 314 25    | 75 076 33 | 1000 1680       |
| saas creative side view R     | 41 314 26    | 75 076 34 | 1000 1681       |

## strip pro smooth

**FIN** Ledvalonauha, jossa yhtenäinen valopinta. **SWE** Led strip med enhetligt ljus. **ENG** Led strip with uniform light surface.

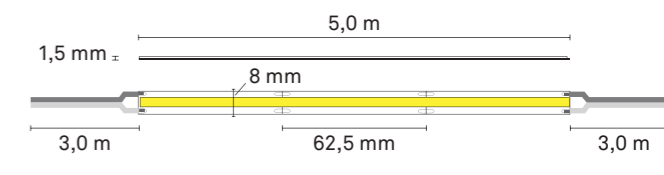

|              |                        |                        |                |                  |                          |     |                                   |
|--------------|------------------------|------------------------|----------------|------------------|--------------------------|-----|-----------------------------------|
| LED 11,5W/m  | 24V                    | 780 lm/m               | Ra 90          | 3 SDCM           | IP20                     | DIM | Temperature icon: -20°C ... +50°C |
| Circuit icon | Scissors icon: 62,5 mm | Scissors icon: 62,5 mm | L90B10 50 000h | 5 YEARS WARRANTY | 60 mm MIN. BEND DIAMETER | CE  |                                   |

\*Lednauha on asennettava jäähdytysprofiiliin | Ljusband måste installera i profil | Led strip must be installed to cooling profile

|                             | Finland      | Sweden    | Europe          |
|-----------------------------|--------------|-----------|-----------------|
|                             | Sähkönumerot | E-Nummer  | Product numbers |
| saas strip pro smooth 2700K | 41 314 33    | 75 076 35 | 1000 1688       |
| saas strip pro smooth 3000K | 41 314 34    | 75 076 36 | 1000 1689       |
| saas strip pro smooth 4000K | 41 314 35    | 75 076 37 | 1000 1690       |



# bluetooth

# dali

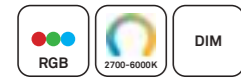
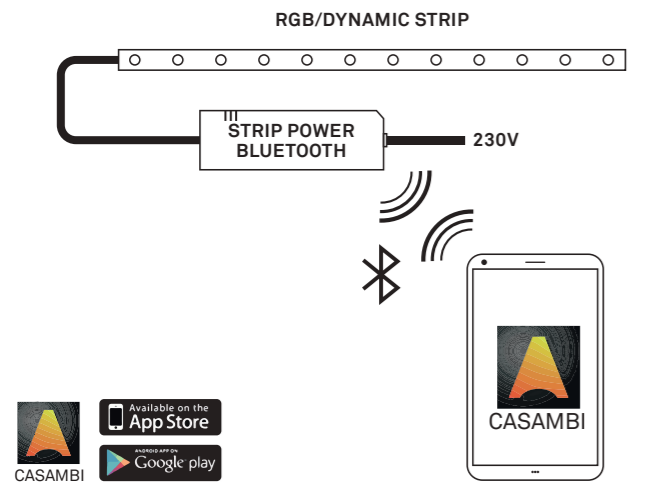

|                            | Finland Sähkönumerot | Sweden E-Nummer | EU Product numbers |
|----------------------------|----------------------|-----------------|--------------------|
| saas strip pro RGB P       | 41 333 67            | 75 076 77       | 1000 1746          |
| saas strip pro RGB P IP67  | 41 333 68            | 75 076 78       | 1000 1747          |
| saas strip power bluetooth | 40 190 42            | 79 822 74       | 1000 1844          |
| saas strip pro dynamic     | 41 314 16            |                 | 1000 0567          |

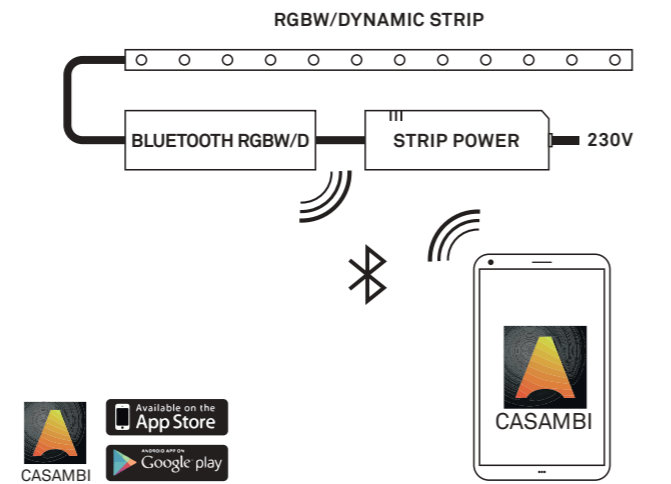

|                        | Finland Sähkönumerot | Sweden E-Nummer | EU Product numbers |
|------------------------|----------------------|-----------------|--------------------|
| saas strip pro RGBW    | 41 333 76            |                 | 1000 1899          |
| saas strip pro dynamic | 41 314 16            |                 | 1000 0567          |
| saas bluetooth RGBW/D  | 40 190 48            |                 | 1000 1970          |

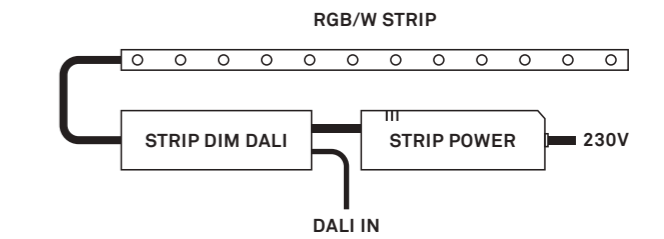
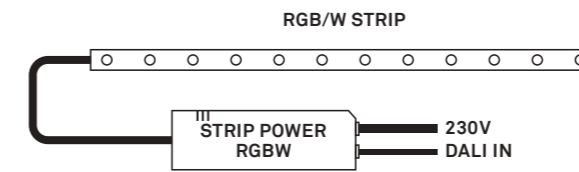

|                              | Finland Sähkönumerot | Sweden E-Nummer | EU Product numbers |
|------------------------------|----------------------|-----------------|--------------------|
| saas strip pro RGB P         | 41 333 67            | 75 076 77       | 1000 1746          |
| saas strip pro RGB P IP67    | 41 333 68            | 75 076 78       | 1000 1747          |
| saas strip pro RGBW          | 41 333 76            |                 | 1000 1899          |
| saas creative top view RGBW  | 41 314 55            | 75 076 86       | 1000 1745          |
| saas creative side view RGBW | 41 314 54            | 75 076 85       | 1000 1744          |
| saas strip power RGBW        | 40 190 37            | 79 809 84       | 1000 1789          |
| saas strip dim dali          | 40 190 21            | 79 809 66       | 1000 0607          |

# RF 2.4 GHz

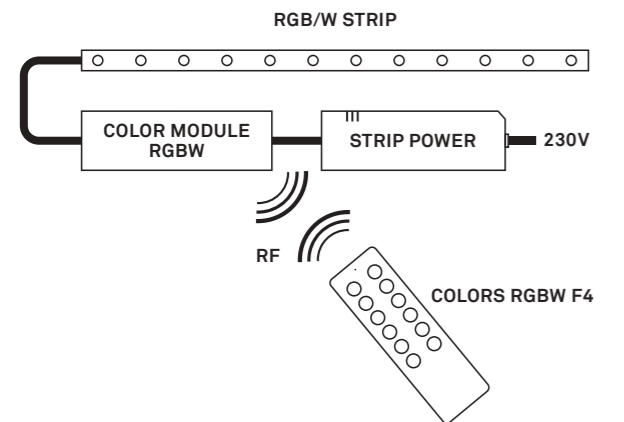

|                              | Finland Sähkönumerot | Sweden E-Nummer | EU Product numbers |
|------------------------------|----------------------|-----------------|--------------------|
| saas strip pro RGB P         | 41 333 67            | 75 076 77       | 1000 1746          |
| saas strip pro RGB P IP67    | 41 333 68            | 75 076 78       | 1000 1747          |
| saas strip pro RGBW          | 41 333 76            |                 | 1000 1899          |
| saas creative top view RGBW  | 41 314 55            | 75 076 86       | 1000 1745          |
| saas creative side view RGBW | 41 314 54            | 75 076 85       | 1000 1744          |
| saas color controller RGBW   | 40 190 46            |                 | 1000 1923          |
| saas color module RGBW       | 40 190 45            |                 | 1000 1924          |

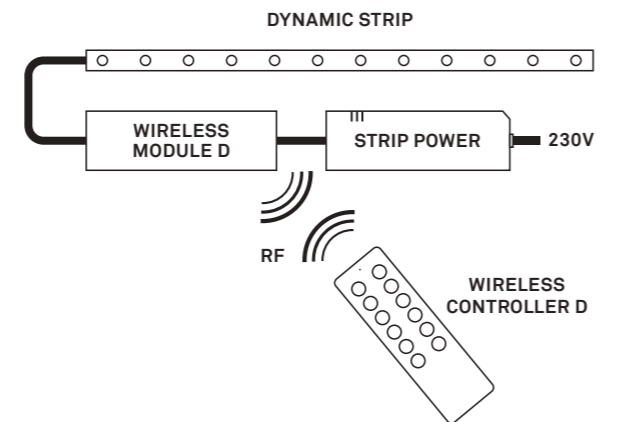

|                            | Finland Sähkönumerot | Sweden E-Nummer | EU Product numbers |
|----------------------------|----------------------|-----------------|--------------------|
| saas strip pro dynamic     | 41 314 16            |                 | 1000 0567          |
| saas wireless controller D | 40 190 47            | 75 076 89       | 1000 1922          |
| saas wireless module D     | 40 190 44            | 75 076 88       | 1000 1921          |





saas strip pro RGBWW

## strip pro RGB P

**FIN** Väriä vaihtava ledvalonauha (RGB) sisäkäyttöön tehostevalaistuksen luomiseen. **SWE** Led strip (RGB) för inomhusbruk för att skapa effekt belysning. **ENG** Led strip (RGB) for indoor use to create effect lighting.

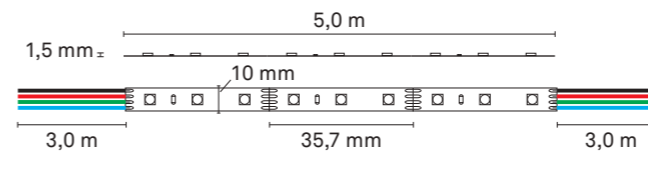

|               |             |     |     |                |                  |                          |     |
|---------------|-------------|-----|-----|----------------|------------------|--------------------------|-----|
| 168 led/m     | LED 17,3W/m | 24V | RGB | 534 lm/m       | 3 SDCM           | IP20                     | DIM |
| -20°C...+50°C |             |     |     | L90B10 50 000h | 5 YEARS WARRANTY | 60 mm MIN. BEND DIAMETER |     |
| CE            |             |     |     |                |                  |                          |     |

\*Lednauha on asennettava jäähdytysprofiiliin | Ljusband måste installera i profil | Led strip must be installed to cooling profile

saas strip pro RGB P

|              |           |                 |
|--------------|-----------|-----------------|
|              |           |                 |
| Sähkönumerot | E-Nummer  | Product numbers |
| 41 333 67    | 75 076 77 | 1000 1746       |

## strip pro RGBWW

**FIN** Väriä vaihtava ledvalonauha (RGB + valkoinen 3000K) sisäkäyttöön tehostevalaistuksen luomiseen. **SWE** Led strip (RGB + vit 3000K) för inomhusbruk för att skapa effekt belysning. **ENG** Led strip (RGB + white 3000K) for indoor use to create effect lighting.

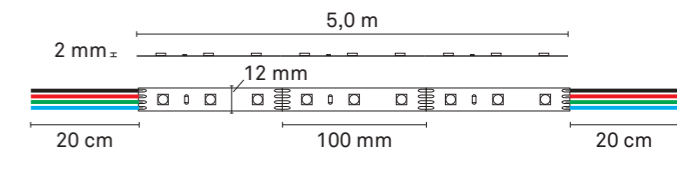

|               |             |     |      |                |                  |                          |     |
|---------------|-------------|-----|------|----------------|------------------|--------------------------|-----|
| 60 led/m      | LED 19,2W/m | 24V | RGBW | 680 lm/m       | 3 SDCM           | IP20                     | DIM |
| -20°C...+50°C |             |     |      | L90B10 50 000h | 5 YEARS WARRANTY | 60 mm MIN. BEND DIAMETER |     |
| CE            |             |     |      |                |                  |                          |     |

\*Lednauha on asennettava jäähdytysprofiiliin | Ljusband måste installera i profil | Led strip must be installed to cooling profile

saas strip pro RGBWW

|              |          |                 |
|--------------|----------|-----------------|
|              |          |                 |
| Sähkönumerot | E-Nummer | Product numbers |
| 41 333 76    |          | 1000 1899       |

## strip pro RGB P IP67

**FIN** Väriä vaihtava ledvalonauha (RGB) sisä- ja ulkokäyttöön tehostevalaistuksen luomiseen. **SWE** Led strip (RGB) för inom- och utomhusbruk för att skapa effekt belysning. **ENG** Led strip (RGB) for indoor and outdoor use to create effect lighting.

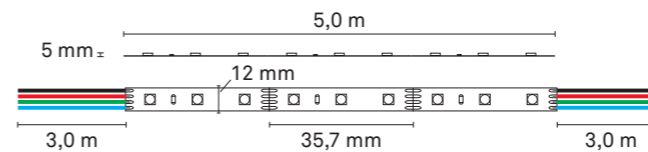

|               |             |     |     |                |                  |                          |     |
|---------------|-------------|-----|-----|----------------|------------------|--------------------------|-----|
| 168 led/m     | LED 17,3W/m | 24V | RGB | 534 lm/m       | 3 SDCM           | IP67                     | DIM |
| -20°C...+50°C |             |     |     | L90B10 50 000h | 5 YEARS WARRANTY | 60 mm MIN. BEND DIAMETER |     |
| CE            |             |     |     |                |                  |                          |     |

\*Lednauha on asennettava jäähdytysprofiiliin | Ljusband måste installera i profil | Led strip must be installed to cooling profile

saas strip pro RGB P IP67

|              |           |                 |
|--------------|-----------|-----------------|
|              |           |                 |
| Sähkönumerot | E-Nummer  | Product numbers |
| 41 333 68    | 75 076 78 | 1000 1747       |





## creative top view RGBW

**FIN** Väriä vaihtava ledvalonauha (RGB + valkoinen 3000K) sisä- ja ulkokäyttöön tehostevalaistuksen luomiseen. Päättä valaiseva. **SWE** Led strip (RGB + vit 3000K) för inom- och utomhusbruk för att skapa effekt belysning. **ENG** Led strip (RGB + white 3000K) for indoor and outdoor use to create effect lighting.

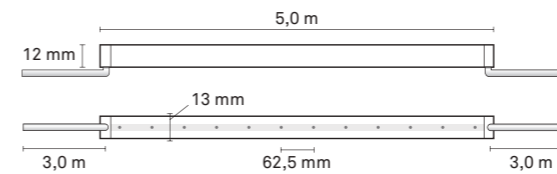

|                 |             |     |                |                  |                          |              |
|-----------------|-------------|-----|----------------|------------------|--------------------------|--------------|
| 60 led/m        | LED 16,5W/m | 24V | RGBW           | IP67             | DIM                      | 15 x BRACKET |
| -20°C ... +50°C |             |     | L90B10 50 000h | 5 YEARS WARRANTY | 60 mm MIN. BEND DIAMETER | CE           |

|                             |              |           |                 |
|-----------------------------|--------------|-----------|-----------------|
|                             |              |           |                 |
|                             | Sähkönumerot | E-Nummer  | Product numbers |
| saas creative top view RGBW | 41 314 55    | 75 076 86 | 1000 1745       |

## creative side view RGBW

**FIN** Väriä vaihtava ledvalonauha (RGB + valkoinen 3000K) sisä- ja ulkokäyttöön tehostevalaistuksen luomiseen. Sivulta valaiseva. **SWE** Led strip (RGB + vit 3000K) för inom- och utomhusbruk för att skapa effekt belysning. **ENG** Led strip (RGB + white 3000K) for indoor and outdoor use to create effect lighting.

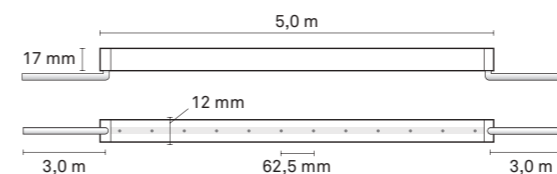

|                 |             |     |                |                  |                          |              |
|-----------------|-------------|-----|----------------|------------------|--------------------------|--------------|
| 60 led/m        | LED 16,5W/m | 24V | RGBW           | IP67             | DIM                      | 15 x BRACKET |
| -20°C ... +50°C |             |     | L90B10 50 000h | 5 YEARS WARRANTY | 60 mm MIN. BEND DIAMETER | CE           |

|                              |              |           |                 |
|------------------------------|--------------|-----------|-----------------|
|                              |              |           |                 |
|                              | Sähkönumerot | E-Nummer  | Product numbers |
| saas creative side view RGBW | 41 314 54    | 75 076 85 | 1000 1744       |



### strip power 24V 36W TRIAC



24V 36W IP20 SW DIM TRIAC   

Sähkönumerot E-Nummer Product numbers  
 saas strip power 24V 36W TRIAC 40 190 14 79 813 91 1000 0595

### strip power 24V 36W DALI



24V 36W IP20 SW DIM DALI   

Sähkönumerot E-Nummer Product numbers  
 saas strip power 24V 36W DALI 40 190 35 79 813 11 1000 1785

### strip power 24V 75W DALI IP67



24V 75W IP67 DALI   

Sähkönumerot E-Nummer Product numbers  
 saas strip power 24V 75W DALI IP67 40 190 41 79 814 72 1000 1843

### strip power 24V 96W



24V 96W IP65 DIM\*   

Sähkönumerot E-Nummer Product numbers  
 saas strip power 24V 96W 40 190 26 79 819 66 1000 1449

### strip power 24V 40W



24V 40W IP67 DIM\*   

Sähkönumerot E-Nummer Product numbers  
 saas strip power 24V 40W 40 190 34 79 822 38 1000 1692

### strip power 24V 60W



24V 60W IP67 DIM\*   

Sähkönumerot E-Nummer Product numbers  
 saas strip power 24V 60W 40 190 10 79 813 14 1000 0593

### strip power 24V 100W DALI



24V 100W IP20 SW DIM DALI   

Sähkönumerot E-Nummer Product numbers  
 saas strip power 24V 100W DALI 40 190 32 79 809 83 1000 1786

### strip power 24V 150W DALI



24V 150W IP20 SW DIM DALI   

Sähkönumerot E-Nummer Product numbers  
 saas strip power 24V 150W DALI 40 190 43 79 822 75 1000 1850

### strip power 24V 75W TRIAC



24V 75W IP20 SW DIM TRIAC   

Sähkönumerot E-Nummer Product numbers  
 saas strip power 24V 75W TRIAC 40 190 27 79 822 37 1000 1559

### strip power 24V 75W DALI



24V 75W IP20 SW DIM DALI   

Sähkönumerot E-Nummer Product numbers  
 saas strip power 24V 75W DALI 40 190 07 79 813 11 1000 0591

### strip power 24V 150W



24V 150W IP67 DIM\*   

Sähkönumerot E-Nummer Product numbers  
 saas strip power 24V 150W 40 190 05 79 809 05 1000 0602

### strip power 24V 240W



24V 240W IP67 DIM\*   

Sähkönumerot E-Nummer Product numbers  
 saas strip power 24V 240W 40 190 22 79 809 65 1000 0600



### strip power D 24V 75W



24V 75W IP20 SW DIM DALI TUNABLE

CE

Sähkönumerot 40 190 23 E-Nummer 79 818 31 Product numbers 1000 0590

### strip power D 24V 100W



24V 100W IP20 SW DIM DALI TUNABLE

CE

Sähkönumerot 40 190 36 E-Nummer 79 809 83 Product numbers 1000 1965

### strip power 24V 150W TRIAC



24V 75W IP20 SW DIM TRIAC

CE

Sähkönumerot 40 190 50 E-Nummer 1000 2610 Product numbers

### strip power RGBW



24V 100W IP20 SW DIM DALI RGBW DT8

CE

Sähkönumerot 40 190 37 E-Nummer 79 809 84 Product numbers 1000 1789

### strip power bluetooth



CASAMBI Available on the App Store Google play

24V 120W IP20 SW 4.0 RGB TUNABLE

CE

Sähkönumerot 40 190 42 E-Nummer 79 822 74 Product numbers 1000 1844

|                                 | IP   | DIM | SW DIM | TRIAC | DALI |
|---------------------------------|------|-----|--------|-------|------|
| saas strip power 24V 36W TRIAC  | IP67 | •   | •      | •     |      |
| saas strip power 24V 36W DALI   | IP20 | •   | •      |       | •    |
| saas strip power 24V 40W        | IP67 | •   |        |       |      |
| saas strip power 24V 60W        | IP67 | •   |        |       |      |
| saas strip power 24V 75W TRIAC  | IP20 | •   | •      | •     |      |
| saas strip power 24V 75W DALI   | IP20 | •   | •      |       | •    |
| saas strip power 24V 75W IP67   | IP67 | •   | •      |       | •    |
| saas strip power 24V 96W        | IP65 | •   |        |       |      |
| saas strip power 24V 100W DALI  | IP20 | •   | •      |       | •    |
| saas strip power 24V 150W DALI  | IP20 | •   | •      |       | •    |
| saas strip power 24V 150W       | IP67 | •   |        |       |      |
| saas strip power 24V 240W       | IP67 | •   |        |       |      |
| saas strip power 24V 150W TRIAC | IP20 | •   | •      | •     |      |

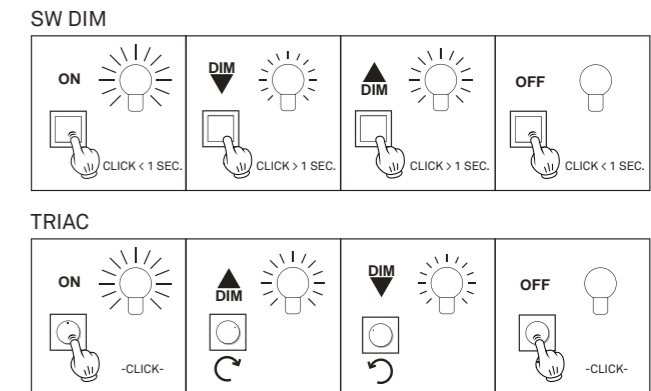

### strip dim



12/24V 12V/144W 24V/288W SW DIM 1-10V DIM IP20

CE

Sähkönumerot 26 047 01 E-Nummer 79 809 40 Product numbers 1000 0651

### strip dim dali



12V 60W / CH 24V 120W / CH IP20 4 CHANNEL SW DIM DALI

CE

Sähkönumerot 40 190 21 E-Nummer 79 809 66 Product numbers 1000 0607

### strip power 24V 36W / 75W / 150W

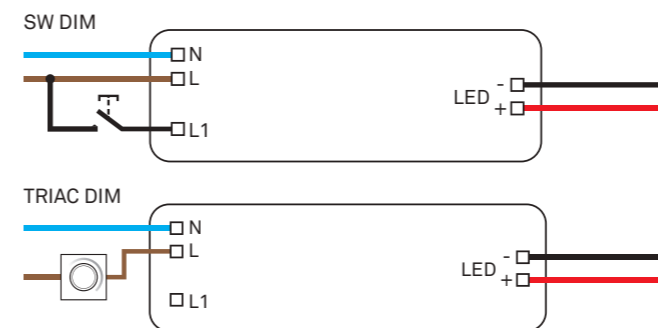

### strip power 24V 36W / 75W / 100W / 150W

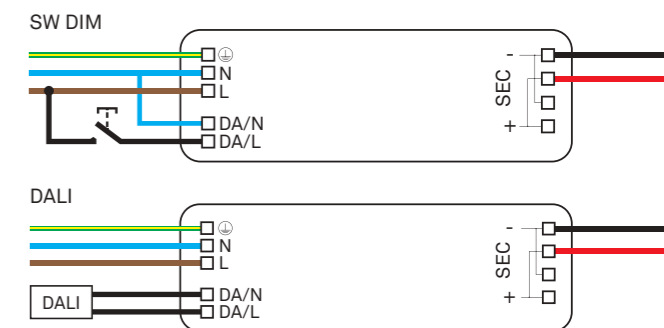

### strip dim dali



### strip dim





strip power 12V 36W TRIAC



12V 36W IP20 SW DIM TRIAC

Sähkönumerot E-Nummer Product numbers  
 saas strip power 12V 36W TRIAC 40 190 00 79 813 09 1000 0597

strip power 12V 36W DALI



12V 36W IP20 SW DIM DALI

Sähkönumerot E-Nummer Product numbers  
 saas strip power 12V 36W DALI 40 190 30 79 813 09 1000 1998

strip power 12V 60W



12V 60W IP67 DIM\* TRIAC

Sähkönumerot E-Nummer Product numbers  
 saas strip power 12V 60W 40 190 17 79 813 93 1000 0594

strip power 12V 75W DALI



12V 75W IP20 SW DIM DALI

Sähkönumerot E-Nummer Product numbers  
 saas strip 12V 75W 40 190 06 79 813 10 1000 0592

strip power 12V 96W



12V 96W IP67 DIM\* TRIAC

Sähkönumerot E-Nummer Product numbers  
 saas strip power 12V 96W 40 190 25 79 819 65 1000 1448

strip power 12V 150W



12V 150W IP67 DIM\* TRIAC

Sähkönumerot E-Nummer Product numbers  
 saas strip power 12V 150W 40 190 18 79 813 95 1000 0603

|                                | IP   | DIM | SW DIM | TRIAC | DALI |
|--------------------------------|------|-----|--------|-------|------|
| saas strip power 12V 36W DALI  | IP20 | •   | •      |       | •    |
| saas strip power 12V 36W TRIAC | IP20 | •   | •      | •     |      |
| saas strip power 12V 60W       | IP67 | •   |        |       | •    |
| saas strip power 12V 75W DALI  | IP20 | •   | •      |       | •    |
| saas strip power 12V 96W       | IP67 | •   |        |       | •    |
| saas strip power 12V 150W      | IP67 | •   |        |       | •    |

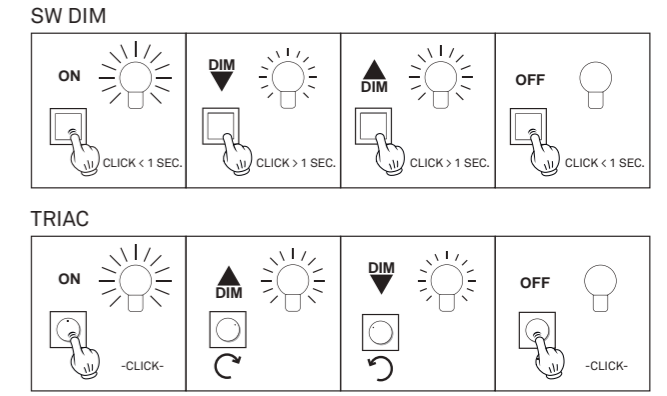

strip power 12V 36W

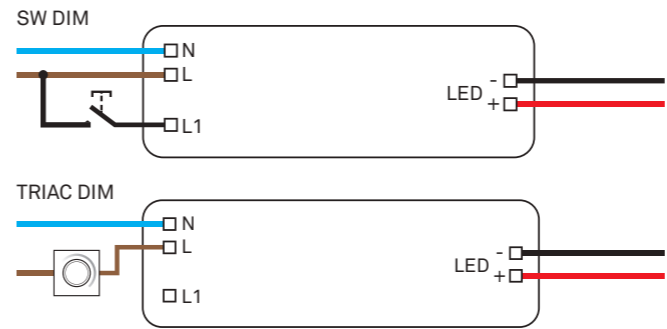

strip power 12V 75W

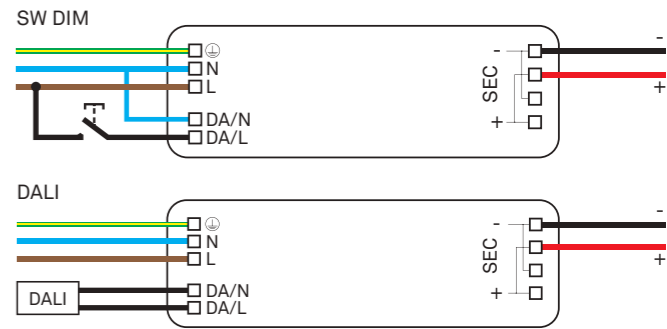

strip dim dali



strip dim





### color controller RGBW



saas color controller RGBW  
 Sähkönumerot E-Nummer Product numbers  
 40 190 46 1000 1923

### color module RGBW



saas color module RGBW  
 Sähkönumerot E-Nummer Product numbers  
 40 190 45 1000 1924

### wireless controller D



saas wireless controller D  
 Sähkönumerot E-Nummer Product numbers  
 40 190 47 75 076 89 1000 1922

### wireless module D

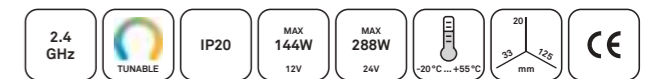

saas wireless module D  
 Sähkönumerot E-Nummer Product numbers  
 40 190 44 75 076 88 1000 1921

### bluetooth RGBW/D



saas bluetooth RGBW/D  
 Sähkönumerot E-Nummer Product numbers  
 40 190 48 1000 1970



### strip rail 2m



Profiilin sisäleveys 15 mm

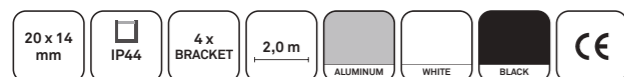

|                    | Finland      | Sweden    | EU             |
|--------------------|--------------|-----------|----------------|
|                    | Sähkönumerot | E-Nummer  | Product number |
| saas strip rail 2m | 41 280 33    | 75 023 08 | 1000 0621      |
|                    | 41 281 44    | 74 514 09 | 1000 0619      |
|                    | 41 281 45    | 74 514 12 | 1000 0620      |

### strip rail 16x07



Profiilin sisäleveys 10,7 mm



|                       | Finland      | Sweden    | EU             |
|-----------------------|--------------|-----------|----------------|
|                       | Sähkönumerot | E-Nummer  | Product number |
| saas strip rail 16x07 | 41 281 64    | 74 514 31 | 1000 0639      |
|                       | 41 281 65    | 74 514 32 | 1000 0637      |
|                       | 41 281 66    | 74 514 33 | 1000 0638      |

### strip rail 08x09



Profiilin sisäleveys 5,2 mm



|                       | Finland      | Sweden    | EU             |
|-----------------------|--------------|-----------|----------------|
|                       | Sähkönumerot | E-Nummer  | Product number |
| saas strip rail 08x09 | 41 281 04    | 74 513 78 | 1000 0645      |
|                       | 41 281 46    | 74 514 13 | 1000 0643      |
|                       | 41 281 47    | 74 514 14 | 1000 0644      |

### strip rail 08x12 U



Profiilin sisäleveys 5,2 mm



|                         | Finland      | Sweden    | EU             |
|-------------------------|--------------|-----------|----------------|
|                         | Sähkönumerot | E-Nummer  | Product number |
| saas strip rail 08x12 U | 41 281 61    | 74 514 28 | 1000 0642      |
|                         | 41 281 62    | 74 514 29 | 1000 0640      |
|                         | 41 281 63    | 74 514 30 | 1000 0641      |

### strip rail 19x19



Profiilin sisäleveys 16 mm



|                       | Finland      | Sweden    | EU             |
|-----------------------|--------------|-----------|----------------|
|                       | Sähkönumerot | E-Nummer  | Product number |
| saas strip rail 19x19 | 41 281 09    | 74 513 83 | 1000 0630      |
|                       | 41 281 56    | 74 514 23 | 1000 0628      |
|                       | 41 281 57    | 74 514 24 | 1000 0629      |

### strip rail 16x16



Profiilin sisäleveys 8 mm



|                       | Finland      | Sweden    | EU             |
|-----------------------|--------------|-----------|----------------|
|                       | Sähkönumerot | E-Nummer  | Product number |
| saas strip rail 16x16 | 41 281 06    | 74 513 80 | 1000 0633      |
|                       | 41 281 50    | 74 514 17 | 1000 0631      |
|                       | 41 281 51    | 74 514 18 | 1000 0632      |

### strip rail 25x13



Profiilin sisäleveys 12,4 mm



|                       | Finland      | Sweden    | EU             |
|-----------------------|--------------|-----------|----------------|
|                       | Sähkönumerot | E-Nummer  | Product number |
| saas strip rail 25x13 | 41 281 05    | 74 513 79 | 1000 0624      |
|                       | 41 281 48    | 74 514 15 | 1000 0622      |
|                       | 41 281 49    | 74 514 16 | 1000 0623      |

### strip rail 24x09



Profiilin sisäleveys 5 mm



|                       | Finland      | Sweden   | EU             |
|-----------------------|--------------|----------|----------------|
|                       | Sähkönumerot | E-Nummer | Product number |
| saas strip rail 24x09 | 41 333 82    |          | 1000 1966      |
|                       | 41 333 84    |          | 1000 1968      |
|                       | 41 333 83    |          | 1000 1967      |

## strip rail 35x35



Profiilin sisäleveys 31 mm

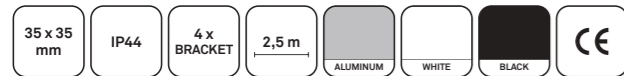

|                       | Sähkönumerot                                  | E-Nummer  | Product number |
|-----------------------|---|-----------|----------------|
| saas strip rail 35x35 | <input type="checkbox"/> 41 281 07            | 74 513 81 | 1000 0618      |
|                       | <input type="checkbox"/> 41 281 52            | 74 514 19 | 1000 0613      |
|                       | <input checked="" type="checkbox"/> 41 281 53 | 74 514 20 | 1000 0617      |

## strip rail 49x32 U



Profiilin sisäleveys 31 mm



|                         | Sähkönumerot                                  | E-Nummer  | Product number |
|-------------------------|---|-----------|----------------|
| saas strip rail 49x32 U | <input type="checkbox"/> 41 281 58            | 74 514 25 | 1000 0616      |
|                         | <input type="checkbox"/> 41 281 59            | 74 514 26 | 1000 0614      |
|                         | <input checked="" type="checkbox"/> 41 281 60 | 74 514 27 | 1000 0615      |

## strip rail 27x11 FLOOR



Profiilin sisäleveys 12 mm



|                             | Sähkönumerot                       | E-Nummer | Product number |
|-----------------------------|------------------------------------|----------|----------------|
| saas strip rail 27x11 FLOOR | <input type="checkbox"/> 41 333 78 |          | 1000 1927      |

## strip rail 25x07



Profiilin sisäleveys 10,7 mm

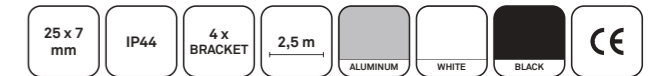

|                       | Sähkönumerot                                  | E-Nummer | Product number |
|-----------------------|---|----------|----------------|
| saas strip rail 25x07 | <input type="checkbox"/> 41 333 79            |          | 1000 1640      |
|                       | <input type="checkbox"/> 41 333 81            |          | 1000 1930      |
|                       | <input checked="" type="checkbox"/> 41 333 80 |          | 1000 1641      |

## strip rail 63x32 U



Profiilin sisäleveys 37,4 mm



|                         | Sähkönumerot                                  | E-Nummer  | Product number |
|-------------------------|---|-----------|----------------|
| saas strip rail 63x32 U | <input type="checkbox"/> 41 281 08            | 74 513 82 | 1000 0612      |
|                         | <input type="checkbox"/> 41 281 54            | 74 514 21 | 1000 0610      |
|                         | <input checked="" type="checkbox"/> 41 281 55 | 74 514 22 | 1000 0611      |

## strip rail 16x13



Profiilin sisäleveys 12,4 mm



|                       | Sähkönumerot                                  | E-Nummer  | Product number |
|-----------------------|---|-----------|----------------|
| saas strip rail 16x13 | <input type="checkbox"/> 41 281 76            | 74 514 36 | 1000 0636      |
|                       | <input type="checkbox"/> 41 281 77            | 74 514 37 | 1000 0634      |
|                       | <input checked="" type="checkbox"/> 41 281 78 | 74 514 38 | 1000 0635      |

## strip rail 23x20



Profiilin sisäleveys 20,5 mm



|                       | Sähkönumerot                       | E-Nummer | Product number |
|-----------------------|------------------------------------|----------|----------------|
| saas strip rail 23x20 | <input type="checkbox"/> 41 333 85 |          | 1000 1946      |

## rail drywall AL



Profiilin sisäleveys 12,4 mm



|                      | Sähkönumerot                       | E-Nummer | Product number |
|----------------------|------------------------------------|----------|----------------|
| saas rail drywall AL | <input type="checkbox"/> 41 314 58 |          | 1000 2532      |





strip rail 2m  
 strip rail 19x19  
 strip rail 16x16  
 strip rail 08x09  
 strip rail 08x12 U  
 strip rail 25x13  
 strip rail 16x07  
 strip rail 16x13  
 strip rail 35x35  
 strip rail 49x32 U  
 strip rail 63x32 U  
 strip rail 27x11 FLOOR  
 strip rail 25x07  
 strip rail 24x09  
 rail drywall AL

|                              |   |   |   |   |   |                     |   |                    |   |                   |   |   |   |   |   |   |   |
|------------------------------|---|---|---|---|---|---------------------|---|--------------------|---|-------------------|---|---|---|---|---|---|---|
| strip pro A++ & NANO         | • | • | • |   |   | •                   | • | •                  | • | •                 | • | • | • | • | • | • | • |
| strip pro A++ IP65           | • | • | • |   |   | •                   | • | •                  | • | •                 | • | • | • |   |   | • | • |
| strip pro P A++ & NANO       | • | • | • |   |   | •                   | • | •                  | • | •                 | • | • | • |   |   | • | • |
| strip pro P A++ IP67         | • | • |   |   |   | •                   | • | •                  | • | •                 | • |   |   |   |   | • | • |
| strip pro SP A++ & NANO      | • | • |   |   |   | •                   | • | •                  | • | •                 | • | • | • |   |   | • | • |
| strip pro mini               | • | • | • | • | • | •                   | • | •                  | • | •                 | • | • | • | • | • | • | • |
| strip pro maxi               |   | • |   |   |   |                     |   |                    | • | •                 | • |   |   |   |   | • |   |
| strip pro maxi IP67          |   | • |   |   |   |                     |   |                    | • | •                 | • |   |   |   |   | • |   |
| strip pro maxi P             |   | • |   |   |   |                     |   |                    | • | •                 | • |   |   |   |   | • |   |
| strip pro maxi P IP67        |   | • |   |   |   |                     |   |                    | • | •                 | • |   |   |   |   | • |   |
| strip pro A++ 50M            | • | • | • |   |   | •                   | • | •                  | • | •                 | • | • | • |   |   | • | • |
| strip pro P A++ 50M          | • | • | • |   |   | •                   | • | •                  | • | •                 | • | • | • |   |   | • | • |
| strip pro superior & NANO    | • | • | • |   |   | •                   | • | •                  | • | •                 | • | • | • |   |   | • | • |
| strip pro superior IP67      | • | • |   |   |   | •                   | • | •                  | • | •                 | • |   |   |   |   | • | • |
| strip pro superior P & NANO  | • | • | • |   |   | •                   | • | •                  | • | •                 | • | • | • |   |   | • | • |
| strip pro superior P IP67    | • | • |   |   |   | •                   | • | •                  | • | •                 | • | • | • |   |   | • |   |
| strip pro superior SP & NANO | • | • |   |   |   | •                   | • | •                  | • | •                 | • | • | • |   |   | • | • |
| creative shortcut P & NANO   | • | • | • |   |   | •                   | • | •                  | • | •                 | • | • | • |   |   | • | • |
| strip pro dynamic            | • | • | • |   |   | •                   | • | •                  | • | •                 | • | • | • |   |   | • | • |
| creative DIM to WARM         | • | • | • |   |   | •                   | • | •                  | • | •                 | • | • | • |   |   | • | • |
| strip pro smooth             | • | • | • |   |   | •                   | • | •                  | • | •                 | • | • | • |   |   | • | • |
| strip pro RGB P              | • | • |   |   |   | •                   | • | •                  | • | •                 | • | • | • |   |   | • | • |
| strip pro RGB P IP67         | • | • |   |   |   | •                   | • | •                  | • | •                 | • | • | • |   |   | • |   |
| strip pro RGBWW              | • | • |   |   |   | •                   | • | •                  | • | •                 | • | • | • |   |   | • |   |
| creative top 06x06           |   |   |   |   |   | PROFIILI SAATAVILLA |   | PROFIL TILLGÄNGLIG |   | PROFILE AVAILABLE |   |   |   |   |   |   |   |
| creative top view RGBW       |   |   |   |   |   | PROFIILI SAATAVILLA |   | PROFIL TILLGÄNGLIG |   | PROFILE AVAILABLE |   |   |   |   |   |   |   |
| creative side view RGBW      |   |   |   |   |   | PROFIILI SAATAVILLA |   | PROFIL TILLGÄNGLIG |   | PROFILE AVAILABLE |   |   |   |   |   |   |   |
| creative top view            |   |   |   |   |   | PROFIILI SAATAVILLA |   | PROFIL TILLGÄNGLIG |   | PROFILE AVAILABLE |   |   |   |   |   |   |   |
| creative side view           |   |   |   |   |   | PROFIILI SAATAVILLA |   | PROFIL TILLGÄNGLIG |   | PROFILE AVAILABLE |   |   |   |   |   |   |   |

Meiltä myös määrämittaen tehdyt valaisinkiskot nopealla toimitusajalla.  
 Kysy myös erikoisprofiileita ja kiinnikkeitä!  
 Pyydä tarjous sähköpostilla

Vi har även måttbeställda profiler med snabb leveranstid.  
 Fråga även om olika profiler och fästen!  
 Begär en offert via e-post

We also have profiles made to measure with a fast delivery time.  
 Also ask for different profiles and fasteners!  
 Request a quote by e-mail

info@saas.fi

bracket

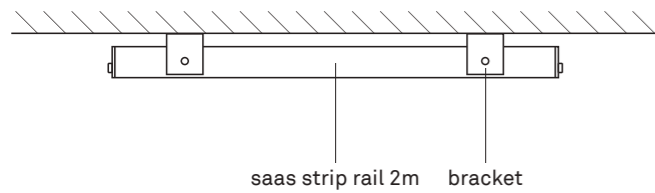
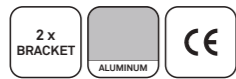

|   | Sähkönumerot | E-Nummer  | Product numbers |
|---|--------------|-----------|-----------------|
| saas bracket  | 41 069 07    | 75 023 10 | 1000 0664       |
| SOVELTUVAT TUOTTEET / FÖR / FOR<br>saas strip rail 2m | 41 280 33    | 75 023 08 | 1000 0621       |

bracket id

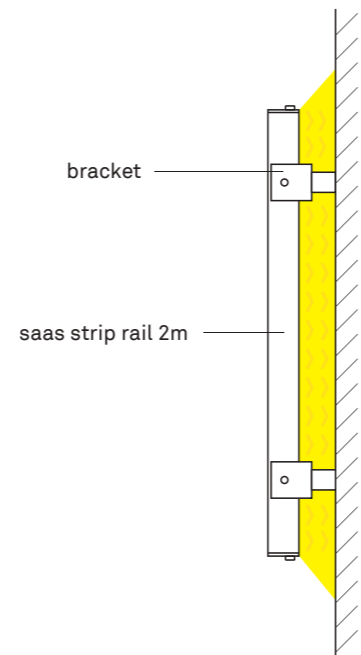
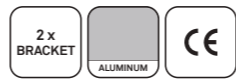

|   | Sähkönumerot | E-Nummer  | Product numbers |
|---|--------------|-----------|-----------------|
| saas bracket id                                       | 41 280 80    | 74 508 68 | 1000 0663       |
| SOVELTUVAT TUOTTEET / FÖR / FOR<br>saas strip rail 2m | 41 280 33    | 75 023 08 | 1000 0621       |

strip dim

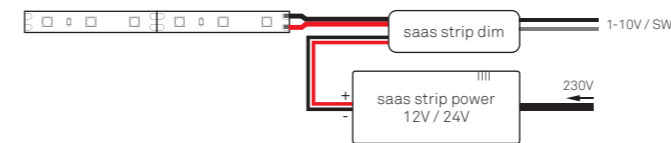

|                | Sähkönumerot | E-Nummer  | Product numbers |
|----------------|--------------|-----------|-----------------|
| saas strip dim | 26 047 01    | 79 809 40 | 1000 0651       |

strip dim dali

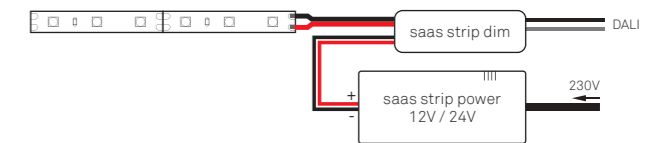
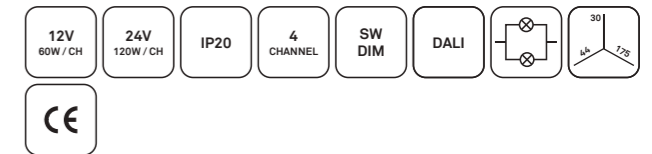

|                     | Sähkönumerot | E-Nummer  | Product numbers |
|---------------------|--------------|-----------|-----------------|
| saas strip dim dali | 40 190 21    | 79 809 66 | 1000 0607       |





OUTDOOR

## saas power floor

**FIN** Valaisin on tehokas ja pienikokoinen ylösvalo. Soveltuu kosteisiin tiloihin.  
**SWE** Markarmaturen är effektiv och kompakt. Lämpig för våtutrymmen.  
**ENG** The fixture is an efficient and compact ground light. Suitable for damp locations.



|           |          |           |              |                         |                   |    |
|-----------|----------|-----------|--------------|-------------------------|-------------------|----|
| LED<br>6W | Ra<br>90 | 3<br>SDCM | 500<br>lumen | 500<br>mA               | -30°C...+50°C     | ⊗  |
| DIM       | IP65     | 45°       | 42 mm        | 2700K<br>3000K<br>4000K | L90B10<br>50 000h | CE |

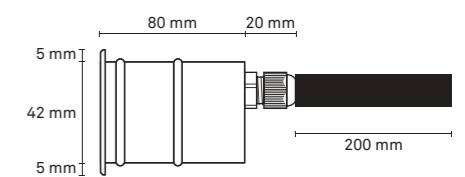

|       | 🇫🇮<br>Sähkönumerot | 🇸🇪<br>E-Nummer | 🇪🇺<br>Product number |
|-------|--------------------|----------------|----------------------|
| 2700K | 45 169 01          | 74 514 03      | 1000 0540            |
| 3000K | 45 169 02          | 74 514 04      | 1000 0538            |
| 4000K | 45 169 03          | 74 514 05      | 1000 0536            |
| 2700K | 45 169 04          | 74 514 06      | 1000 0539            |
| 3000K | 45 169 05          | 74 514 07      | 1000 0537            |
| 4000K | 45 169 06          | 74 514 08      | 1000 0535            |









saas shepherd

## saas shepherd

**FIN** Shepherd on Mikko Paakkasen suunnittelema ulkovalaisin. Mattamusta väri, korkealaatuinen LED ja muoto tekee tästä valaisimesta tyylikkään luomuksen sekä pihalle että terassille. **SWE** Shepherd är en armatur för utomhusbruk designad av Mikko Paakkanen. Med sin mattsvarta färg och kvalitets LED blir denna snygga armatur en naturlig partner i din trädgård eller på din terrass. **ENG** The Shepherd is an outdoor light designed by Mikko Paakkanen. With its matte black color and high quality LED it becomes a stylish partner for your garden or terrace.



|           |          |               |                   |           |      |     |
|-----------|----------|---------------|-------------------|-----------|------|-----|
| LED<br>6W | Ra<br>90 | 3<br>SDCM     | 500<br>lumen      | 500<br>mA | IP65 | DIM |
| DMX       | DALI     | -20°C...+50°C | L90B10<br>50 000h | CE        |      |     |

## saas power moon

**FIN** Power moon on ulkovalaisin suunnattavalla valonlähteellä. Valaisinta on saatavilla kahdella eri pituudella. Tyylikkään designin ja valaisimen mattamustan värin johdosta valaisin sopii erinomaisesti pihalle tai terassille. **SWE** Power moon är en utomhusarmatur med justerbar ljuskälla och kan beställas i två olika längder. Med sin mattsvarta färg och snygga design är denna armatur det perfekta alternativet för din gård eller terrass. **ENG** The power moon is an outdoor light with a directable light source. The fixture comes in two different lengths. With its matte black color and sleek design, it's the perfect piece for your garden or terrace.

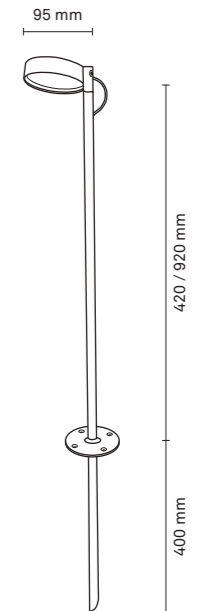

|           |          |               |                   |           |      |     |
|-----------|----------|---------------|-------------------|-----------|------|-----|
| LED<br>7W | Ra<br>90 | 3<br>SDCM     | 600<br>lumen      | 350<br>mA | IP65 | DIM |
| DMX       | DALI     | -20°C...+50°C | L90B10<br>50 000h | CE        |      |     |



saas power moon

|       | 🇫🇮 Sähkönumerot | 🇸🇪 E-Nummer | 🇪🇺 Product number |
|-------|-----------------|-------------|-------------------|
| 2700K | 45 158 05       |             | 1000 1806         |
| 3000K | 45 158 04       |             | 1000 1804         |
| 4000K | 45 158 06       |             | 1000 1805         |

|                     | 🇫🇮 Sähkönumerot | 🇸🇪 E-Nummer | 🇪🇺 Product number |
|---------------------|-----------------|-------------|-------------------|
| saas power moon 420 | 2700K           | 45 158 11   | 1000 1829         |
|                     | 3000K           | 45 158 07   | 1000 1825         |
|                     | 4000K           | 45 158 09   | 1000 1827         |
| saas power moon 920 | 2700K           | 45 158 12   | 1000 1830         |
|                     | 3000K           | 45 158 08   | 1000 1826         |
|                     | 4000K           | 45 158 10   | 1000 1828         |



## saas power focus stem

**FIN** Power focus stem on ulkovalaisin, joka sopii erinomaisesti pihan yksityiskohtien valaisuun. Valaisimessa on suunnattava valonlähde ja säädettävä valokeila. **SWE** Power focus stem är en utomhusarmatur med riktbar ljuskälla och en efter installation justerbar ljuskägla. **ENG** The power focus stem is an outdoor fixture with a directable light source and adjustable beam angle.



|        |       |               |                |        |      |     |
|--------|-------|---------------|----------------|--------|------|-----|
| LED 6W | Ra 90 | 3 SDCM        | 500 lumen      | 500 mA | IP65 | DIM |
| DMX    | DALI  | -20°C...+50°C | L90B10 50 000h | CE     |      |     |

## saas power slope

**FIN** Valonlähteen ollessa täysin piilossa valo valuu kauniisti ulos valaisten pehmeästi kulkuväyliä. **SWE** Då ljuskällan är helt gömd på denna armatur blir effekten ett mjukt och diskret ljus som effektivt lyser upp stigar och gångar. **ENG** The hidden light source on this fixture creates a soft and pretty light towards the pathway ahead.

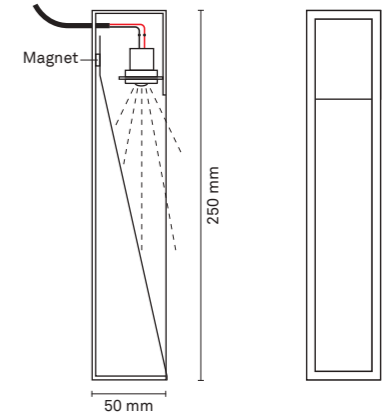

|                   |                |           |        |               |     |      |
|-------------------|----------------|-----------|--------|---------------|-----|------|
| LED 6W            | Ra 90          | 500 lumen | 500 mA | -20°C...+50°C | DIM | IP65 |
| 2700K 3000K 4000K | L90B10 50 000h | CE        |        |               |     |      |

|                           |       | 🇫🇮 Sähkönumerot | 🇸🇪 E-Nummer | 🇪🇺 Product number |
|---------------------------|-------|-----------------|-------------|-------------------|
| saas power focus stem 420 | 2700K | 45 158 15       |             | 1000 1809         |
|                           | 3000K | 45 158 13       |             | 1000 1807         |
|                           | 4000K | 45 158 14       |             | 1000 1808         |
| saas power focus stem 920 | 2700K | 45 158 16       |             | 1000 1810         |
|                           | 3000K | 45 158 17       |             | 1000 1811         |
|                           | 4000K | 45 158 18       |             | 1000 1812         |

|       | 🇫🇮 Sähkönumerot | 🇸🇪 E-Nummer | 🇪🇺 Product number |
|-------|-----------------|-------------|-------------------|
| 2700K | 45 158 19       |             | 1000 2510         |
| 3000K | 45 158 20       |             | 1000 2511         |
| 4000K | 45 158 21       |             | 1000 2512         |



# DESIGN LIGHTS





# TUBE

Design Esa Vesmanen



|           |              |           |                         |        |  |  |
|-----------|--------------|-----------|-------------------------|--------|--|--|
| LED<br>3W | 200<br>lumen | 700<br>mA | 2700K<br>3000K<br>4000K | ON/OFF |  |  |
|           |              |           |                         |        |  |  |

# STICK

Design Saas Instruments



|           |              |           |                         |      |        |
|-----------|--------------|-----------|-------------------------|------|--------|
| LED<br>6W | 500<br>lumen | 500<br>mA | 2700K<br>3000K<br>4000K | IP44 | ON/OFF |
|           |              |           |                         |      |        |



# SUB

Design Timo Hoisko & Matti Korpela



|            |      |                |      |        |  |  |
|------------|------|----------------|------|--------|--|--|
| LED<br>40W | 230V | 3000K<br>4000K | IP44 | ON/OFF |  |  |
|            |      |                |      |        |  |  |

# BUBBLE

Design Saas Instruments



|               |     |                         |     |      |        |
|---------------|-----|-------------------------|-----|------|--------|
| LED<br>35-90W | 24V | 2700K<br>3000K<br>4000K | RGB | IP20 | ON/OFF |
|               |     |                         |     |      |        |



# TREFOIL

Design Simo Serpola



|            |       |       |      |
|------------|-------|-------|------|
| LED<br>18W | 500mA | 3000K | IP44 |
| ON/OFF     | BLACK | OAK   | CE   |

# PIPELINE

Design Saas Instruments



|           |          |                         |       |
|-----------|----------|-------------------------|-------|
| LED<br>6W | 700mA    | 500mA                   | 3000K |
|           | PIPELINE | PIPELINE<br>+ DOWNLIGHT | 4000K |
| IP44      | ON/OFF   | CE                      |       |



|                 | 2700K     |           |           |           | 3000K     |           |           |           | 4000K     |  |  |  |  |
|-----------------|-----------|-----------|-----------|-----------|-----------|-----------|-----------|-----------|-----------|--|--|--|--|
| sauna+          | 41 281 91 | 41 281 92 | 41 281 93 | 41 281 16 | 41 069 53 | 41 069 57 | 41 069 42 | 41 069 54 | 41 069 58 |  |  |  |  |
| sauna id+       | 41 281 96 | 41 281 95 | 41 281 94 | 41 280 68 | 41 280 70 | 41 280 72 | 41 280 74 | 41 280 75 | 41 280 76 |  |  |  |  |
| posh sauna glow |           |           |           | 41 281 10 |           |           |           |           |           |  |  |  |  |
| sauna viiva     | 41 314 29 |           |           |           |           |           |           |           |           |  |  |  |  |
| hot one         |           |           |           | 41 280 54 |           |           |           |           |           |  |  |  |  |
| hot one+        |           |           |           | 41 280 56 |           |           |           |           |           |  |  |  |  |
| sauna basic     |           |           |           | 41 280 51 |           |           |           |           |           |  |  |  |  |
| sauna sky       |           |           |           | 41 280 53 |           |           |           |           |           |  |  |  |  |
| sauna compact   |           |           |           | 41 314 56 |           |           |           |           |           |  |  |  |  |
| löyly           | 41 314 28 | 41 314 27 |           |           |           |           |           |           |           |  |  |  |  |

|                | 2700K     |           |           |           | 3000K     |           |           |           | 4000K     |           |           |           |  |
|----------------|-----------|-----------|-----------|-----------|-----------|-----------|-----------|-----------|-----------|-----------|-----------|-----------|--|
| spot+          | 41 281 82 | 41 281 79 | 41 281 81 | 41 281 80 | 41 069 22 | 41 280 19 | 41 280 14 | 41 280 17 | 41 069 48 | 41 280 20 | 41 280 16 | 41 280 18 |  |
| wide+          | 41 281 83 | 41 281 86 | 41 281 84 | 41 281 85 | 41 069 18 | 41 069 84 | 41 069 80 | 41 069 82 | 41 069 44 | 41 069 88 | 41 069 81 | 41 069 83 |  |
| step+          | 41 281 87 | 41 281 90 | 41 281 88 | 41 281 89 | 41 069 20 | 41 280 05 | 41 069 97 | 41 069 99 | 41 069 46 | 41 280 06 | 41 069 98 | 41 280 04 |  |
| diagonal       | 41 281 98 | 41 314 01 | 41 281 99 | 41 314 00 | 41 069 35 | 41 280 30 | 41 280 25 | 41 280 28 | 41 280 24 | 41 280 32 | 41 280 26 | 41 280 29 |  |
| focus          | 41 314 03 |           | 41 314 02 |           | 41 069 34 |           | 41 280 96 |           | 41 280 37 |           | 41 280 97 |           |  |
| power focus    | 41 281 28 | 41 281 34 | 41 281 31 |           | 41 281 29 | 41 281 35 | 41 281 32 |           | 41 281 30 | 41 281 36 | 41 281 33 |           |  |
| power spot     | 41 314 06 | 41 314 08 | 41 314 07 |           | 41 280 39 | 41 280 40 | 41 280 38 |           | 41 280 43 | 41 280 44 | 41 280 42 |           |  |
| power spot R   | 41 281 19 | 41 281 22 | 41 281 25 |           | 41 281 20 | 41 281 23 | 41 281 26 |           | 41 281 21 | 41 281 24 | 41 281 27 |           |  |
| posh hidden    |           | 41 314 10 | 41 314 09 |           |           | 41 314 11 |           |           |           | 41 314 12 | 41 281 12 |           |  |
| posh diamond S |           |           |           |           |           |           | 41 280 78 |           |           |           |           |           |  |
| posh diamond R |           |           |           |           |           |           | 41 280 77 |           |           |           |           |           |  |
| posh diamond C |           |           |           |           |           |           | 41 280 79 |           |           |           |           |           |  |

|                      | 2700K     |           | 3000K     |           | 4000K     |           |
|----------------------|-----------|-----------|-----------|-----------|-----------|-----------|
| power floor          | 45 169 01 | 45 169 04 | 45 169 02 | 45 169 05 | 45 169 03 | 45 169 06 |
| shepherd             |           | 45 158 05 |           | 45 158 04 |           | 45 158 06 |
| power moon 420       |           | 45 158 11 |           | 45 158 07 |           | 45 158 09 |
| power moon 920       |           | 45 158 12 |           | 45 158 08 |           | 45 158 10 |
| power focus stem 420 |           | 45 158 15 |           | 45 158 13 |           | 45 158 14 |
| power focus stem 920 |           | 45 158 16 |           | 45 158 17 |           | 45 158 18 |
| power slope          |           | 45 158 19 |           | 45 158 20 |           | 45 158 21 |

LIITÄNTÄLAITTEET

|                    |           |
|--------------------|-----------|
| dim                | 41 069 32 |
| maxi dim           | 41 280 45 |
| dim R              | 40 190 13 |
| dim bluetooth      | 40 190 39 |
| maxi dim bluetooth | 40 190 40 |
| dim TRIAC          | 40 190 29 |
| driver             | 40 190 02 |
| driver 500mA       | 41 280 46 |
| driver one led     | 41 281 18 |
| move               | 40 190 03 |

JOHTOSARJAT

|              |           |
|--------------|-----------|
| wire 8       | 41 069 03 |
| wire 8 XS    | 41 281 13 |
| wire 8 XL    | 41 280 60 |
| wire 12      | 41 280 61 |
| wire 16      | 41 280 62 |
| cable + 2,5m | 41 069 31 |
| cable + 5m   | 41 314 04 |

LISÄTARVIKKEET

|         |   |
|---------|---|
| loop 10 | 41 280 63                                     |
| loop 30 | 41 280 64                                     |
| square  | 41 069 23 <input type="checkbox"/>            |
|         | 41 280 23 <input type="checkbox"/>            |
|         | 41 280 21 <input checked="" type="checkbox"/> |
|         | 41 280 22 <input checked="" type="checkbox"/> |

LED STRIP

| A++                        | 2700K     | 3000K     | 4000K     |
|----------------------------|-----------|-----------|-----------|
| strip pro A++              |           | 41 333 27 | 41 333 28 |
| strip pro A++ IP65 NANO    |           | 41 333 31 | 41 333 32 |
| strip pro A++ IP65         |           | 41 333 29 | 41 333 30 |
| strip pro P A++            |           | 41 333 33 | 41 333 34 |
| strip pro P A++ IP65 NANO  |           | 41 333 37 | 41 333 38 |
| strip pro P A++ IP67       |           | 41 333 35 | 41 333 36 |
| strip pro SP A++           |           | 41 333 39 | 41 333 40 |
| strip pro SP A++ IP65 NANO |           | 41 333 41 | 41 333 42 |
| strip pro mini             | 41 314 15 | 41 281 02 | 41 281 03 |
| strip pro maxi             |           | 41 281 71 | 41 281 72 |
| strip pro maxi IP67        |           | 41 281 69 | 41 281 70 |
| strip pro maxi P           |           | 41 281 73 | 41 281 74 |
| strip pro maxi P IP67      |           | 41 333 86 | 41 333 87 |
| strip pro A++ 50M          |           | 41 333 92 | 41 333 93 |
| strip pro P A++ 50M        |           | 41 333 95 | 41 333 94 |

| SUPERIOR                        | 2700K     | 3000K     | 4000K     |
|---------------------------------|-----------|-----------|-----------|
| strip pro superior              | 41 333 43 | 41 333 44 | 41 333 45 |
| strip pro superior IP65 NANO    | 41 333 49 | 41 333 50 | 41 333 51 |
| strip pro superior IP67         | 41 333 46 | 41 333 47 | 41 333 48 |
| strip pro superior P            | 41 333 52 | 41 333 53 | 41 333 54 |
| strip pro superior P IP65 NANO  | 41 333 58 | 41 333 59 | 41 333 60 |
| strip pro superior P IP67       | 41 333 55 | 41 333 56 | 41 333 57 |
| strip pro superior SP           | 41 333 61 | 41 333 62 | 41 333 63 |
| strip pro superior SP IP65 NANO | 41 333 64 | 41 333 65 | 41 333 66 |

| CREATIVE                      | 2700K     | 3000K     | 4000K     | RGB/W/D   | SIN.      | PUN.      |
|-------------------------------|-----------|-----------|-----------|-----------|-----------|-----------|
| creative shortcut P           | 41 333 69 | 41 333 70 | 41 333 71 |           |           |           |
| creative shortcut P IP65 NANO | 41 333 72 | 41 333 73 | 41 333 74 |           |           |           |
| strip pro dynamic             |           |           |           | 41 314 16 |           |           |
| creative DIM to WARM          |           |           |           | 41 333 88 |           |           |
| creative top view             | 41 314 17 | 41 314 21 | 41 314 19 |           | 41 314 18 | 41 314 20 |
| creative side view            | 41 314 22 | 41 314 23 | 41 314 24 |           | 41 314 25 | 41 314 26 |
| creative top 06x06            | 41 333 91 | 41 333 89 | 41 333 90 |           |           |           |
| strip pro smooth              | 41 314 33 | 41 314 34 | 41 314 35 |           |           |           |
| strip pro RGB P               |           |           |           | 41 333 67 |           |           |
| strip pro RGB P IP67          |           |           |           | 41 333 68 |           |           |
| strip pro RGBWW               |           |           |           | 41 333 76 |           |           |
| creative top view RGBW        |           |           |           | 41 314 55 |           |           |
| creative side view RGBW       |           |           |           | 41 314 54 |           |           |

| VIRTALÄHTEET 24V              |           |
|-------------------------------|-----------|
| strip power 24V 36W TRIAC     | 40 190 14 |
| strip power 24V 36W DALI      | 40 190 35 |
| strip power 24V 40W           | 40 190 34 |
| strip power 24V 60W           | 40 190 10 |
| strip power 24V 75W TRIAC     | 40 190 27 |
| strip power 24V 75W DALI      | 40 190 07 |
| strip power 24V 75W DALI IP67 | 40 190 41 |
| strip power 24V 96W           | 40 190 28 |
| strip power 24V 100W DALI     | 40 190 32 |
| strip power 24V 150W DALI     | 40 190 43 |
| strip power 24V 150W          | 40 190 05 |
| strip poewr 24V 240W          | 40 190 22 |
| strip power 24V 75W D         | 40 190 23 |
| strip power 24V 100W D        | 40 190 36 |
| strip power RGBW              | 40 190 37 |
| strip power bluetooth         | 40 190 42 |
| strip power 24V 150W TRIAC    | 40 190 50 |
| strip power RGBW              | 40 190 37 |

| VIRTALÄHTEET 12V          |           |
|---------------------------|-----------|
| strip power 12V 36W TRIAC | 40 190 00 |
| strip power 12V 36W       | 40 190 20 |
| strip power 12V 36W DALI  | 40 190 30 |
| strip power 12V 60W       | 40 190 17 |
| strip power 12V 75W       | 40 190 06 |
| strip power 12V 96W       | 40 190 25 |
| strip power 12V 150W      | 40 190 18 |

| ALUMIINIPIIFILIT       |           |           |           |
|------------------------|-----------|-----------|-----------|
| strip rail 2m          | 41 280 33 | 41 281 44 | 41 281 45 |
| strip rail 16x07       | 41 281 64 | 41 281 65 | 41 281 66 |
| strip rail 19x19       | 41 281 09 | 41 281 56 | 41 281 57 |
| strip rail 16x16       | 41 281 06 | 41 281 50 | 41 281 51 |
| strip rail 08x09       | 41 281 04 | 41 281 46 | 41 281 47 |
| strip rail 08x12 U     | 41 281 61 | 41 281 62 | 41 281 63 |
| strip rail 25x13       | 41 281 05 | 41 281 48 | 41 281 49 |
| strip rail 24x09       | 41 333 82 | 41 333 84 | 41 333 83 |
| strip rail 35x35       | 41 281 07 | 41 281 52 | 41 281 53 |
| strip rail 49x32 U     | 41 281 58 | 41 281 59 | 41 281 60 |
| strip rail 63x32 U     | 41 281 08 | 41 281 54 | 41 281 55 |
| strip rail 16x13       | 41 281 76 | 41 281 77 | 41 281 78 |
| strip rail 27x11 FLOOR | 41 333 78 |           |           |
| strip rail 25x07       | 41 333 79 |           |           |
| strip rail 23x20       | 41 333 85 | 41 333 81 | 41 333 80 |
| rail drywall AL        | 41 314 58 |           |           |

| LISÄTARVIKKEET          |           |
|-------------------------|-----------|
| bracket                 | 41 069 07 |
| bracket id              | 41 280 80 |
| strip dim               | 26 047 01 |
| strip dim DALI          | 40 190 21 |
| color controller RGBW   | 40 190 46 |
| color module RGBW       | 40 190 45 |
| wireless controller D   | 40 190 47 |
| wireless module D       | 40 190 44 |
| bluetooth RGBW/D        | 40 190 48 |
| saas quick W-to-S 8 mm  | 41 333 96 |
| saas quick W-to-S 10 mm | 41 333 97 |
| saas quick S-to-S 8 mm  | 41 333 98 |
| saas quick S-to-S 10 mm | 41 333 99 |

|                 | 2700K     |           |           | 3000K     |           |           | 4000K     |           |           |
|-----------------|-----------|-----------|-----------|-----------|-----------|-----------|-----------|-----------|-----------|
| sauna+          | 74 508 06 | 74 507 08 | 74 507 09 | 74 527 88 | 74 507 42 | 74 507 44 | 74 507 41 | 74 507 43 | 74 507 45 |
| sauna id+       | 74 508 47 | 74 508 48 | 74 508 49 | 74 508 52 | 74 508 53 | 74 508 54 | 74 508 55 | 74 508 56 | 74 508 57 |
| posh sauna glow |           |           |           | 74 508 95 |           |           |           |           |           |
| sauna viiva     |           |           |           |           |           |           |           |           |           |
| hot one         |           |           |           | 74 800 51 |           |           |           |           |           |
| hot one+        |           |           |           | 74 800 52 |           |           |           |           |           |
| sauna basic     |           |           |           | 74 800 02 |           |           |           |           |           |
| sauna sky       |           |           |           | 74 800 03 |           |           |           |           |           |
| sauna compact   |           |           |           | 74 800 28 |           |           |           |           |           |
| löyly           | 75 064 77 | 75 064 78 |           |           |           |           |           |           |           |

|             | 2700K     |           |           |           | 3000K     |           |           |           | 4000K     |           |           |           |
|-------------|-----------|-----------|-----------|-----------|-----------|-----------|-----------|-----------|-----------|-----------|-----------|-----------|
| spot+       | 74 506 99 | 74 508 18 | 74 508 16 | 74 508 17 | 74 527 94 | 74 507 86 | 74 507 82 | 74 507 84 | 74 507 81 | 74 507 87 | 74 507 83 | 74 507 85 |
| wide+       | 74 508 08 | 74 507 26 | 74 507 24 | 74 507 25 | 74 527 90 | 74 507 58 | 74 507 54 | 74 507 56 | 74 507 53 | 74 507 59 | 74 507 55 | 74 507 57 |
| step+       | 74 508 10 | 74 508 12 | 74 508 02 | 74 508 11 | 74 527 92 | 74 507 72 | 74 507 68 | 74 507 70 | 74 507 67 | 74 507 73 | 74 507 69 | 74 507 71 |
| diagonal    | 74 507 04 | 74 508 21 | 74 508 19 | 74 508 20 | 74 526 79 | 74 507 93 | 74 507 89 | 74 507 91 | 74 507 88 | 74 507 94 | 74 507 90 | 74 507 92 |
| focus       | 74 507 05 |           | 74 508 87 |           | 74 526 78 |           | 74 508 88 |           | 74 507 99 |           | 74 508 89 |           |
| power focus | 74 513 94 | 74 514 00 | 74 513 97 |           | 74 513 95 | 74 514 01 | 74 513 98 |           | 74 513 96 | 74 514 02 | 74 513 99 |           |

| SAUNA           |           |           |           |           |           |           |           |           |           |
|-----------------|-----------|-----------|-----------|-----------|-----------|-----------|-----------|-----------|-----------|
|                 | 2700K     |           |           | 3000K     |           |           | 4000K     |           |           |
| sauna+          | 1000 0464 | 1000 0463 | 1000 0462 | 1000 0459 | 1000 0461 | 1000 0460 | 1000 0458 | 1000 0457 | 1000 0456 |
| sauna id+       | 1000 0473 | 1000 0472 | 1000 0471 | 1000 0470 | 1000 0469 | 1000 0468 | 1000 0467 | 1000 0466 | 1000 0465 |
| posh sauna glow |           |           |           | 1000 0477 |           |           |           |           |           |
| sauna viiva     | 1000 1606 |           |           |           |           |           |           |           |           |
| hot one         |           |           |           | 1000 0675 |           |           |           |           |           |
| hot one+        |           |           |           | 1000 0673 |           |           |           |           |           |
| sauna basic     |           |           |           | 1000 0672 |           |           |           |           |           |
| sauna sky       |           |           |           | 1000 0669 |           |           |           |           |           |
| sauna compact   |           |           |           | 1000 1754 |           |           |           |           |           |
| loyly           | 1000 1480 | 1000 1479 |           |           |           |           |           |           |           |

| DOWNLIGHTS     |           |           |           |           |           |           |           |           |           |           |           |           |
|----------------|-----------|-----------|-----------|-----------|-----------|-----------|-----------|-----------|-----------|-----------|-----------|-----------|
|                | 2700K     |           |           |           | 3000K     |           |           |           | 4000K     |           |           |           |
| spot+          | 1000 0455 | 1000 0452 | 1000 0454 | 1000 0453 | 1000 0448 | 1000 0449 | 1000 0451 | 1000 0450 | 1000 0447 | 1000 0444 | 1000 0446 | 1000 0445 |
| wide+          | 1000 0431 | 1000 0428 | 1000 0430 | 1000 0429 | 1000 0424 | 1000 0425 | 1000 0427 | 1000 0426 | 1000 0423 | 1000 0420 | 1000 0422 | 1000 0421 |
| step+          | 1000 0443 | 1000 0440 | 1000 0442 | 1000 0441 | 1000 0436 | 1000 0437 | 1000 0439 | 1000 0438 | 1000 0435 | 1000 0432 | 1000 0434 | 1000 0433 |
| diagonal       | 1000 0504 | 1000 0505 | 1000 0507 | 1000 0506 | 1000 0500 | 1000 0501 | 1000 0503 | 1000 0502 | 1000 0499 | 1000 0496 | 1000 0498 | 1000 0497 |
| focus          | 1000 0492 |           | 1000 0491 |           | 1000 0489 |           | 1000 0490 |           | 1000 0488 |           | 1000 0487 |           |
| power focus    | 1000 0534 | 1000 0532 | 1000 0533 |           | 1000 0531 | 1000 0529 | 1000 0530 |           | 1000 0528 | 1000 0526 | 1000 0527 |           |
| power spot     | 1000 0513 | 1000 0510 | 1000 0516 |           | 1000 0512 | 1000 0509 | 1000 0515 |           | 1000 0511 | 1000 0508 | 1000 0514 |           |
| power spot R   | 1000 0525 | 1000 0523 | 1000 0524 |           | 1000 0522 | 1000 0520 | 1000 0521 |           | 1000 0519 | 1000 0517 | 1000 0518 |           |
| posh hidden    |           | 1000 0482 | 1000 0483 |           | 1000 0480 |           | 1000 0481 |           | 1000 0478 |           | 1000 0479 |           |
| posh diamond S |           |           |           |           |           |           | 1000 0484 |           |           |           |           |           |
| posh diamond R |           |           |           |           |           |           | 1000 0486 |           |           |           |           |           |
| posh diamond C |           |           |           |           |           |           | 1000 0485 |           |           |           |           |           |

| OUTDOOR              |           |           |           |           |           |           |
|----------------------|-----------|-----------|-----------|-----------|-----------|-----------|
|                      | 2700K     |           | 3000K     |           | 4000K     |           |
| power floor          | 1000 0540 | 1000 0539 | 1000 0538 | 1000 0537 | 1000 0536 | 1000 0535 |
| shepherd             |           | 1000 1806 |           | 1000 1804 |           | 1000 1805 |
| power moon 420       |           | 1000 1829 |           | 1000 1825 |           | 1000 1827 |
| power moon 920       |           | 1000 1830 |           | 1000 1826 |           | 1000 1828 |
| power focus stem 420 |           | 1000 1809 |           | 1000 1807 |           | 1000 1808 |
| power focus stem 920 |           | 1000 1810 |           | 1000 1811 |           | 1000 1812 |
| power slope          |           | 1000 2510 |           | 1000 2511 |           | 1000 2512 |

| DRIVDON            |           | KABEL SERIER |           | TILLBEHÖR |           |
|--------------------|-----------|--------------|-----------|-----------|-----------|
| dim                | 1000 0550 | wire 8       | 1000 0648 | loop 10   | 1000 0658 |
| maxi dim           | 1000 0542 | wire 8 XS    | 1000 0646 | loop 30   | 1000 0657 |
| dim R              | 1000 0549 | wire 8 XL    | 1000 0647 | square    | 1000 0655 |
| dim bluetooth      | 1000 1821 | wire 12      | 1000 0650 |           | 1000 0652 |
| maxi dim bluetooth | 1000 1820 | wire 16      | 1000 0649 |           | 1000 0654 |
| dim TRIAC          | 1000 1635 | cable + 2,5m | 1000 0662 |           | 1000 0653 |
| driver             | 1000 0547 | cable + 5m   | 1000 0661 |           |           |
| driver 500mA       | 1000 0546 |              |           |           |           |
| driver one led     | 1000 0543 |              |           |           |           |
| move               | 1000 0656 |              |           |           |           |

LED STRIP

| A++                        |           |           |           | SUPERIOR                        |           |           |           |
|----------------------------|-----------|-----------|-----------|---------------------------------|-----------|-----------|-----------|
|                            | 2700K     | 3000K     | 4000K     |                                 | 2700K     | 3000K     | 4000K     |
| strip pro A++              |           | 1000 1693 | 1000 1694 | strip pro superior              | 1000 1714 | 1000 1712 | 1000 1713 |
| strip pro A++ IP65 NANO    |           | 1000 1697 | 1000 1698 | strip pro superior IP65 NANO    | 1000 1719 | 1000 1720 | 1000 1721 |
| strip pro A++ IP65         |           | 1000 1696 | 1000 1695 | strip pro superior IP67         | 1000 1717 | 1000 1715 | 1000 1716 |
| strip pro P A++            |           | 1000 1704 | 1000 1700 | strip pro superior P            | 1000 1723 | 1000 1718 | 1000 1722 |
| strip pro P A++ IP65 NANO  |           | 1000 1699 | 1000 1703 | strip pro superior P IP65 NANO  | 1000 1725 | 1000 1727 | 1000 1728 |
| strip pro P A++ IP67       |           | 1000 1702 | 1000 1701 | strip pro superior P IP67       | 1000 1724 | 1000 1726 | 1000 1729 |
| strip pro SP A++           |           | 1000 1705 | 1000 1706 | strip pro superior SP           | 1000 1730 | 1000 1732 | 1000 1733 |
| strip pro SP A++ IP65 NANO |           | 1000 1707 | 1000 1708 | strip pro superior SP IP65 NANO | 1000 1731 | 1000 1734 | 1000 1735 |
| strip pro mini             | 1000 0584 | 1000 0555 | 1000 0554 |                                 |           |           |           |
| strip pro maxi             |           | 1000 0561 | 1000 0559 |                                 |           |           |           |
| strip pro maxi IP67        |           | 1000 0560 | 1000 0558 |                                 |           |           |           |
| strip pro maxi P           |           | 1000 0557 | 1000 0556 |                                 |           |           |           |
| strip pro maxi P IP67      |           | 1000 1975 | 1000 1976 |                                 |           |           |           |
| strip pro A++ 50M          |           | 1000 2412 | 1000 2413 |                                 |           |           |           |
| strip pro P A++ 50M        |           | 1000 2415 | 1000 2414 |                                 |           |           |           |

| CREATIVE                      |           |           |           |           |           |           |
|-------------------------------|-----------|-----------|-----------|-----------|-----------|-----------|
|                               | 2700K     | 3000K     | 4000K     | RGB/W/D   | SIN.      | PUN.      |
| creative shortcut P           | 1000 1736 | 1000 1742 | 1000 1737 |           |           |           |
| creative shortcut P IP65 NANO | 1000 1748 | 1000 1740 | 1000 1741 |           |           |           |
| strip pro dynamic             |           |           |           | 1000 0567 |           |           |
| creative DIM to WARM          |           |           |           | 1000 2038 |           |           |
| creative top view             | 1000 1673 | 1000 1677 | 1000 1675 |           | 1000 1674 | 1000 1676 |
| creative side view            | 1000 1672 | 1000 1678 | 1000 1679 |           | 1000 1680 | 1000 1681 |
| creative top 06x06            | 1000 2391 | 1000 2392 | 1000 2393 |           |           |           |
| strip pro smooth              | 1000 1688 | 1000 1689 | 1000 1690 |           |           |           |
| strip pro RGB P               |           |           |           | 1000 1746 |           |           |
| strip pro RGB P IP67          |           |           |           | 1000 1747 |           |           |
| strip pro RGBWW               |           |           |           | 1000 1899 |           |           |
| creative top view RGBW        |           |           |           | 1000 1745 |           |           |
| creative side view RGBW       |           |           |           | 1000 1744 |           |           |

| POWER SUPPLY 24V              |           | POWER SUPPLY 12V          |           | ALUMINIUM PROFILES     |           |           | ACCESSORIES |                         |           |
|-------------------------------|-----------|---------------------------|-----------|------------------------|-----------|-----------|-------------|-------------------------|-----------|
| strip power 24V 36W TRIAC     | 1000 0595 | strip power 12V 36W TRIAC | 1000 0597 | strip rail 2m          | 1000 0621 | 1000 0619 | 1000 0620   | bracket                 | 1000 0664 |
| strip power 24V 36W DALI      | 1000 1785 | strip power 12V 36W       | 10000596  | strip rail 16x07       | 1000 0639 | 1000 0637 | 1000 0638   | bracket id              | 1000 0663 |
| strip power 24V 40W           | 1000 1692 | strip power 12V 36W DALI  | 1000 1998 | strip rail 19x19       | 1000 0630 | 1000 0628 | 1000 0629   | strip dim               | 1000 0651 |
| strip power 24V 60W           | 1000 0593 | strip power 12V 60W       | 1000 0594 | strip rail 16x16       | 1000 0633 | 1000 0631 | 1000 0632   | strip dim DALI          | 1000 0607 |
| strip power 24V 75W TRIAC     | 1000 1559 | strip power 12V 75W       | 1000 0592 | strip rail 08x09       | 1000 0645 | 1000 0643 | 1000 0644   | color controller RGBW   | 1000 1923 |
| strip power 24V 75W DALI      | 1000 0591 | strip power 12V 96W       | 1000 1448 | strip rail 08x12 U     | 1000 0642 | 1000 0640 | 1000 0641   | color module RGBW       | 1000 1924 |
| strip power 24V 75W DALI IP67 | 1000 1843 | strip power 12V 150W      | 1000 0603 | strip rail 25x13       | 1000 0624 | 1000 0622 | 1000 0623   | wireless controller D   | 1000 1922 |
| strip power 24V 96W           | 1000 1449 |                           |           | strip rail 24x05       | 1000 1966 | 1000 1968 | 1000 1967   | wireless module D       | 1000 1921 |
| strip power 24V 100W DALI     | 1000 1786 |                           |           | strip rail 35x35       | 1000 0618 | 1000 0613 | 1000 0617   | bluetooth RGBW/D        | 1000 1970 |
| strip power 24V 150W DALI     | 1000 1850 |                           |           | strip rail 49x32 U     | 1000 0616 | 1000 0614 | 1000 0615   | saas quick W-to-S 8 mm  | 1000 2408 |
| strip power 24V 150W          | 1000 0602 |                           |           | strip rail 63x32 U     | 1000 0612 | 1000 0610 | 1000 0611   | saas quick W-to-S 10 mm | 1000 2409 |
| strip power 24V 240W          | 1000 0600 |                           |           | strip rail 16x13       | 1000 0636 | 1000 0634 | 1000 0635   | saas quick S-to-S 8 mm  | 1000 2410 |
| strip power 24V 75W D         | 1000 0590 |                           |           | strip rail 27x11 FLOOR | 1000 0636 | 1000 0634 | 1000 0635   | saas quick S-to-S 10 mm | 1000 2411 |
| strip power 24V 100W D        | 1000 1965 |                           |           | strip rail 25x07       | 1000 1640 | 1000 1930 | 1000 1641   |                         |           |
| strip power RGBW              | 1000 1789 |                           |           | strip rail 23x20       | 1000 1946 |           |             |                         |           |
| strip power bluetooth         | 1000 1844 |                           |           | rail drywall AL        | 1000 2532 |           |             |                         |           |
| strip power 24V 150W TRIAC    | 1000 2610 |                           |           |                        |           |           |             |                         |           |
| strip power RGBW              | 1000 1789 |                           |           |                        |           |           |             |                         |           |



S.A.S.F.I

*Since*



SaaS Instruments